

"Planning Your Own Website? Free Help On Page 26."

ICD08635

POPULAR COMMUNICATIONS

JANUARY 2000

**World In Crisis: Dropping In On
The Planet's Trouble Spots With
Your Shortwave Radio!**

- **Alice Opens The File On
A WWII Mystery Station**
- **Pop'Comm Spotlights:
*Uniden Bearcat BC-245XLT
TrunkTracker II**



0 75470 08635 9

**PLUS: The Pirate's Den, Clandestine Communique,
Radio News and much more!**

THE VR-500 BRINGS YOU THE WORLD!

CARRY THE WORLD WITH YOU!



Ultra Compact Size!
58 mm x 24 mm x 95 mm
220 g (including Antenna / Battery)
 Simulated display / keypad illumination

Continuous Coverage:
100 kHz to 1299.99995* MHz!

*Cellular telephone frequencies are blocked and cannot be restored.

All Mode Reception:
 FM, Wide-FM, USB, LSB, CW, and AM!

Huge Memory Capacity:
1091 Channels!

Actual Size

Features

- Multiple Power Source Capability
- Direct Keypad Frequency Entry
- Large High-Output Speaker
- Polycarbonate Case
- Real-Time 60-ch* Band Scope
*Range 6 MHz / Step 100 kHz
- Full Illumination For Display And Keypad
- Versatile Squelch / Monitor Key
- Convenient "Preset" Operating Mode
- Huge 1091-ch Memory System With Search & Scan
- Regular Memories (1000 ch)
- Search Band Memories (10 ch)
- Preset Channel Memories (19 ch + 10 Weather Channels)
- Dual Watch Memories (10 ch)
- Priority Memory (1 ch)
- Smart Search™ Memories (11/21/31/41 ch)

- Convenience Features
- 1 MHz Fast Steps
- Front-end 20 dB Attenuator
- RF Squelch
- Power On / Power Off Timers
- Adjustable Battery Saver
- Extensive Menu Customization
- Clone Capability
- Computer Control

COMMUNICATIONS RECEIVER
VR-500
 All-Mode Wideband Receiver



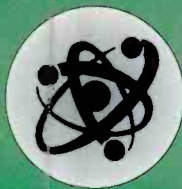

LENTINI

COMMUNICATIONS, INC.

Toll Free
1-800-666-0908
 In CT 860-666-6227

PCR1000



\$399.95
 Special
 Sale price
 w/ICOM
 coupon

Communications Receiver For Computer

- Covers .01-1300MHz
- All Mode WFM, FM, AM, SSB, CW
- Employs Band-Tracking RF Filters
- Connects to Your PC Exter.

NEW PCR100, Similar to PCR1000 Less SSB \$199.95 SALE
 UPS included

IC-R10



- Wideband, All Mode Receive Capability From 100 kHz to 1300 MHz.
- 1000 Memory Chan. With 8-Character Alphanumeric Names.
- Many Other Features!

\$299.95 Special Sale price w/ICOM coupon
 UPS included

IC-R8500



Communications Receiver

- Wideband, All Mode Receive From 0.1 to 2000 MHz.
- Many Features Similar to IC-R10

CALL FOR PRICING!

ICOM

\$199.95
 UPS Inc.



Ultra Compact, Super Wide Band

- The New Mini-Sized Scanner From ICOM is Now Available.
- 500kHz-1.3GHz (Less Cellular) AM/FM/WFM.
- Loud And Crisp Audio, Backlit LCD.
- Triple Conversion, Built-In Attenuator.
- 400 Memories, 8 Banks of 50 Chan.
- CTCSS Tone Squelch and Tone Search.
- Includes 2 AA Size Ni-Cd Batteries and Charger.
- PC Programmable (Software and Connection Cable Optional).
- More!

IC-R2

IC-R75



\$799.95
 UPS Inc.

NEW IC-R75 HF Receiver

- Receives .03-60MHz, AM/FM/SSB/CW/RTTY
 - Triple Conversion Receiver
 - Synchronous AM detection
 - Twin Passband Tuning
 - Automatic Notch Filter
 - Front Mounted Speaker
 - Optional Digital Signal Processing
 - Up to Two Optional Filters
- Call for More Info**

SANGEAN

ATS909

ATS909 Shortwave Receiver

- AM/FM Stereo/USB/LSB
- 306 Memory Presets, 29 Separate Pages
- RDS Reception
- Lighted LED Clock with Alarm
- Including Carrying Case, SW Antenna, Earplugs
- Much More



\$249.95 + \$8 UPS

uniden

BC895XLT

BC245XLT



\$229.95
 UPS Included

BC9000XLT \$359.95
 BC3000XLT \$359.95



\$219.95
 UPS Included

UPS included

AOR

USA, Inc

AR8200B

ALSO AVAILABLE

NEW AR-16B

Mini Handheld 500kHz - 1.36MHz (Cellular Blocked)

\$219.95

NEW!

- 5-2040MHz
- AM, NFM, WFM, SSB, CW, Alpha-Num.
- Computer Prog.
- AR8000B
- AR5000 + 3
- AR7030 Plus

FULL LINE OF AOR ACCESSORIES

CALL FOR MORE INFO & PRICING
 Unblocked versions available to qualified agencies

\$549.95

YAESU

FT-90R

World's Smallest High-Power Dual-Band Mobile!

Freq Coverage:
 RX 100-230MHz,
 300-530MHz
 810-999.975
 (Cellular Blocked)
 TX 144-148MHz
 430-450 MHz

- 50 Watts (2M) 35 Watts (UHF)
- Only 3.9" Wide, 1.2" High x 5.4" Deep!
- AM Aircraft Receive
- CTCSS/DCS Encode/Decode
- Remotable
- Much More!

\$399.95
 UPS Included

Yaesu/Vertex VXF-10 ADVENTURER



Available in Black, Yellow (Special Order)

- 14 Channel Digital Coded FRS Two-Way Radio with National Weather Service Reception.
- 500mW RF Output Power/2 Mile Range.
- No License Required.

each only **\$99.95**
 or 2 for **\$189.95**

VX-5R

Yaesu VX-5R Tri Band Handheld Transceiver

- Wide Band Receive RX: 0.5 - 15.995 MHz, 48-728.990 MHz, 800-998.990 MHz (Cellular Blocked)
- TX: 50-54 MHz, 144-148 MHz, 430-450 MHz
- 5W Power Output
- 220 Memories
- AM/NFM/WFM
- CTCSS
- Encode/Decode, Digital Code, Squelch (DCS)
- 8 Character Alpha Display.
- ADMS-1E
- Windows™
- PC Programmable (Optional)
- Much, Much More

NEW!



CALL FOR PRICING!

VR-500

High Performance Miniature Communications Receiver

- Freq Range: 100kHz to 1300 MHz
- All-Mode! AM/WFM/NFM/LSB/USB/CW
- 1000 Memory Channels
- 8 Character Alpha Numeric Display.
- Direct Keypad Frequency Entry
- Dual Watch/Band Scope
- Much More!

\$329.95



Call For Availability and Pricing!

Drake Shortwave Radios		Galaxy CB	
R8B (new)	\$1159.95 + \$14 UPS	DX949 AM/SSB Mobile	\$199.95
SW8	\$779.95 + \$10 UPS	DX959 AM/SSB Mobile, Freq Counter	\$249.95
SW2	\$399.95 + \$7 UPS		
SW1	\$199.95 + \$7 UPS		
SONY		Galaxy 10 Meter	
ICF-2010	\$349.95 + \$7 UPS	DX33HML	\$219.95
ICF-SW07	\$389.95 + \$7 UPS	DX55V	\$219.95
ICF-SW77	\$469.95 + \$7 UPS	DX44	\$249.95
ICF-7600G	\$169.95 + \$6 UPS	DX77HML	\$299.95
ICF-7600GS	\$219.95 + \$7 UPS	DX66V	\$329.95
ICF-SW1000TS	\$469.95 + \$7 UPS	DX73V	\$339.95
ICF-SV100S	\$369.95 + \$7 UPS	DX2517 Base	\$499.00
		DX89HL	\$379.95
		DX99V	\$399.95
TEKK PRO-SPORT		2 Year Factory Warranty on All Galaxy	
TF-461-FRS 14 Channels.... Each \$69.95 pair for \$129.95			

uniden	
SC2000 Handheld Scanner	• CTCSS
	• DCS DPL
	• Alpha-Numeric Display
	• Call For Pricing
GRUNDIG	
Shortwave	
Yacht Boy 400PE	\$199.00
	UPS Included
Yacht Boy 205	SALE \$49.95
Analog Shortwave	

RELM	
MS180	
\$169.95	UPS Included
HS200	
\$199.95	UPS Included

NEW! ALINCO	
DJ-X10	
Wide Range Receiver	
• Multi-Mode Reception	
• From .1 to 2000MHz.	
• Channel Scope.	
• AM/WFM/FM/SSB/CW.	
• 1200 Memories.	
• Superb Sensitivity, Clear Sound.	
	\$379.95

HOURS: M-F 10am - 6pm SAT 10am-4pm UPS Ground (48 states)

Conn Sales Infor. & Tech Help 860-666-6227

Web Site: www.lentinicomm.com

21 Garfield St. Newington, CT 06111

C.O.D.'s OK
 SAME DAY
 SHIPPING



CIRCLE 145 ON READER SERVICE CARD

Contents

POPULAR COMMUNICATIONS

Volume 18, Number 5

January 2000



8 Millennium? Don't Celebrate Here! Checking Out The World's Hot Spots From The Comfort Of Home by Gerry L. Dexter

16 The Abominable Dr. Fritz, On The Air! Was He Hitler's Little Helper Or A Homegrown Hooligan? by Alice Brannigan

Product Spotlight:

62 • Uniden Bearcat BC-245XLT TrunkTracker II by Ken Reiss

22 What On Earth Is EMC And EMI? Antennas & Things

26 Planning Your Own Website? Here's Help... Radio & The Internet

30 Restoring The American Bosch Tombstone Radio The Radio Connection

35 Looking For An Inexpensive, Used 3-30 MHz SSB Rig? Radio Resources

38 Colombian Guerrilla Station Expanding, And Hearing Burma Is Easy! Clandestine Communiqué

40 Navigating International SW BC Bands The Easy Way World Band Tuning Tips

44 Forget Y2K, Pirate Stations WILL Be On The Air! The Pirate's Den

46 A Beverage To Whet Your Appetite Broadcast DXing

49 Radio And Computer Connections, Part II Scan Tech

54 Hamfests: Goodies Galore — And Real Live Hams! The Ham Column

56 WTJC Picks A Frequency, And A New Dominican Republic Station On The Air... The Listening Post

60 Telecommunications In The New Millennium Washington Beat

66 CB Predictions For The New Year And Beyond CB Scene

70 New Caribbean Counter-Narcotic Net Frequencies And Calls! Communications Confidential

80 Y2K Predictions The Loose Connection

Departments

- 4 Tuning In — An Editorial
- 6 Pop'Comm P.O.— Letters
- 21 How I Got Started
- 42 Product Parade
- 79 Readers' Market

On The Cover

A U.S. Air Force F-15E Eagle flies above snow-covered mountains over Northern Iraq during a routine patrol in support of Operation Northern Watch. Coalition enforcement of the no-fly zone keeps Saddam in check. Gerry Dexter's five-page article, "Millennium? Don't Celebrate Here," beginning on page 8, gives you frequencies and times so YOU can hear more than 50 shortwave stations from countries in turmoil. (DOD Photo by Captain Patricia Lang, U.S. Air Force and inset photo of B-52H Stratofortress pilot over Kosovo by Senior Airman Greg L. Davis, U.S. Air Force)

Visit us on the Web: www.popular-communications.com

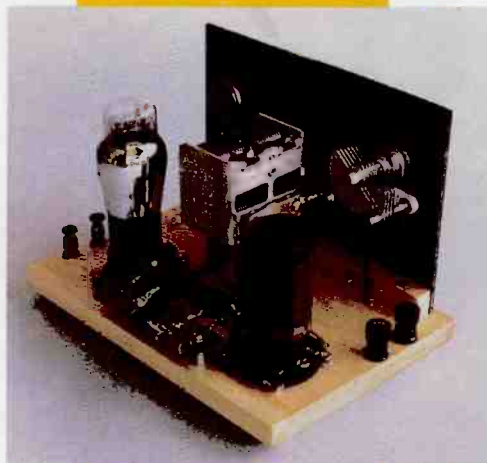

30

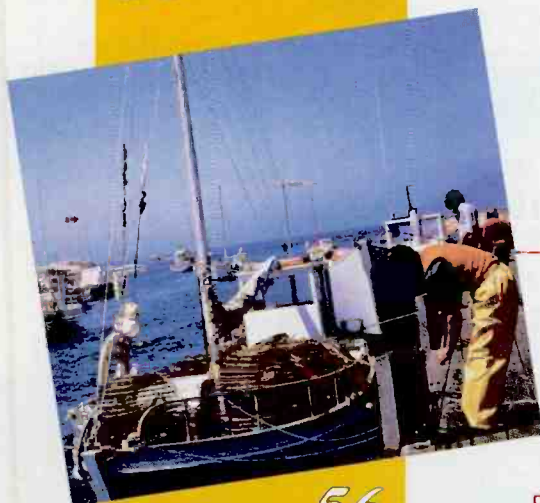

56

Universal Radio - Quality equipment since 1942.

New 2000 Edition!

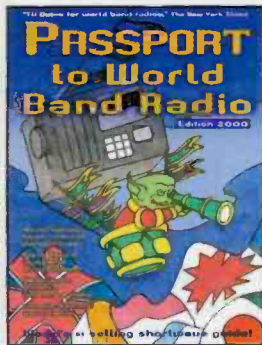

PASSPORT TO WORLD BAND RADIO 2000 NEW

By Larry Magne. A must have book for every worldband listener. Here is everything you need to know about when and where to hear the world; hour by hour, country by country and frequency by frequency. Also includes candid, hard-hitting reviews of current portable and worldband radios. An expanded station address section is also featured. **Passport** is the world's number one selling shortwave guide. An indispensable reference with over 500 pages. Special price!

Order #1000 \$19.95 **\$15.90** (+\$2)

Through the magic of D.S.P., the **TEN-TEC RX-320** receiver provides features and performance previously unavailable even at twice the price. See the review in *Passport 2000* or contact Universal Radio for complete details. **RX-320** Order #0320 \$294.95 (+\$7)



SW1

- Full Coverage
- LW/MW/SW
- Digital Readout
- Keypad Entry
- 32 Memories
- RF Gain



The **Drake SW1** sets the stage for worldwide shortwave listening with ease, simplicity and clarity. Coverage from 100 through 30000 kHz provides solid coverage of longwave, medium wave and shortwave in the AM mode (no SSB). This makes it an ideal broadcast receiver for the desk or bed-stand. Tuning is a snap via the keypad, manual tuning knob, Up/Down buttons or 32 memories. The huge LED display features 1 kHz readout. Antenna input is via a 50 ohm terminal or SO-239 jack. A 1/8" mini jack is provided for use with earplug or headphones (not supplied). Operates from 12 VDC or supplied AC adapter.

Order #1100 \$249.95 **Sale \$199.99** (+\$7 UPS)

RADIO BOOKS

- Shortwave Receivers Past & Present *3rd Edit.*

This huge 473 page guide covers over 770 receivers from 98 manufacturers, made from 1942-1997. Entry information includes: receiver type, date sold, photograph, size & weight, features, reviews, specifications, new & used values, variants, value rating & availability. 120 new pages. Become an instant receiver expert! #0003 \$24.95 (+\$2)



- World Radio TV Handbook 2000 *New Edition*
- Joe Carr's Receiving Antenna Handbook
- Pirate Radio *By A. Yoder With audio CD!*

Here is the incredible saga of America's underground illegal broadcasters (with audio CD). #3038 **Sale \$26.90** (+\$2)

- Worldwide Aeronautical Frequency Dir. *By R. Evans*

The definitive guide to commercial and military, HF and VHF-UHF aeronautical communications including ACARS. Second Ed. 260 Pgs. #0042 **Sale \$16.90** (+\$2)

- Scanner Radio Guide *By L.M. Barker*
- Discover DX'ing! *By J. Zondlo New Second Edition*
- Shortwave Listening Guide *By H. Helms 2nd Edition*

Here is understandable information on: selecting and operating a shortwave receiver, simple antennas, time stations, pirates and much more. With informative tables and diagrams. 323 Pages. #2984 **\$19.95 Sale \$16.90** (+\$2)

- Emergency Survival Communications *By D. Ingram*
- Be prepared. Covers home systems, shortwave, ham, CB, scanners, weather, alternate power sources, solar power, generators, batteries, Y2K, etc. #3691 **\$19.95** (+\$2)

US\$ Please add \$2 per title for surface shipping.



Dressler active antennas are German designed and German manufactured. They provide outstanding performance for both the hobbyist and professional user and can be mounted for stationary or mobile receiving applications. Universal now stocks these shortwave antenna models covering 40 kHz to 40 MHz (with 40 foot coax):

- ARA40 Order #4061 \$229.95 (+\$9)
- ARA60 Order #4062 \$279.95 (+\$9)
- ARA100HDX Order #4063 \$529.95 (+\$12)

For wideband monitoring Dressler offers the ARA2000 (shown) and the ARA2000HDX (for high RF environments). Coverage is 50-2000 MHz (with 40 foot coax):

- ARA2000 Order #4064 \$309.95 (+\$9)
- ARA2000HDX Order #4065 \$629.95 (+\$9)

Visit www.universal-radio.com for full technical details.



HUGE FREE CATALOG

The huge **Universal Communications Catalog** covers everything for shortwave, amateur and scanner enthusiasts. This informative 120 page catalog is our biggest ever. Many new items are featured including the new **ICOM R75**, **Grundig YB-300 PE** and **Sony ICF-SW07** receivers. This catalog is **FREE** by bookrate or \$3 by Priority mail. Rising postage costs prevent us from sending this catalog out automatically so please **request your free copy today!**



Universal Radio, Inc.
6830 Americana Pkwy.
Reynoldsburg, Ohio
43068-4113 U.S.A.

- ☎ 800 431-3939 Orders & Prices
- ☎ 614 866-4267 Information
- ☎ 614 866-2339 FAX Line
- ✉ dx@universal-radio.com



www.DXing.com

www.universal-radio.com

- Visa
- MasterCard
- Discover
- Prices and specs. are subject to change.
- Returns subject to a 15% restocking fee.
- Used equipment list available on request.

tuning in

An Editorial

Prepared For 2000: When Is Enough, Enough?

A few months ago — heck, yes, right up to last night — I'll admit that my preoccupation with Y2K and the Millennium was making friends and colleagues more than crazy. Most of my family fully expected me to pack up my radios, antennas, solar panels, and batteries and head for a musty old cabin in the Ozarks in a very-used '63 Chevy van. Such a plan might be worth considering, but I'd need two vans just to truck all the radio stuff.

Sure enough, as soon as our September article on alternative energy hit the streets, the calls, letters, and E-mail poured in; most of them very interesting and insightful. A short letter from Rich Klingman in Mt. Upton, New York, stood out in the crowd. He says, "I really enjoyed Harold's article . . . but one thing puzzles me: Why bother to go to all that trouble, when for about the same price as the batteries mentioned, plus the arrays of solar cells, one could buy a good generator?"

Sure as Bill Price will run out of toilet paper on New Year's Eve right after dinner at Taco Bell, it hit me. Could this fellow be right? Sounds like one of those questions that only someone on top of the Nation's pulse like Billy Tauzin or Ed Markey would be able to answer. Why go through all the trouble of constructing a small solar energy system when a generator will do the trick? Well, like they say, one man's chocolate donut is another man's filet mignon. Or something like that. Point is, solar energy is reasonably efficient, less expensive in the long-run, and environmentally-friendly. And let's not forget that you can't run the darned generator in your garage or (without a condo war) on your balcony. Imagine the lines of SUVs at gas stations stocking up on fuel to keep the generators running. Where *do* you store 15 bazillion gallons of fuel?

Oh sure, for some folks generators make good sense. If you've got a well-stocked refrig (not here, we ate all the food!) or medical situation, like Rich's

father (he's on a home oxygen unit) then it's more than a little bit convenient.

As I write these words, 60 days shy of 2000, a voice (the same one that tells me to bypass Dunkin Donuts on the way to work) keeps saying "Hey, dummy, get a small generator — just in case." Perhaps the voice is right. But I don't think so. After all, we've got 30 gallons of bottled water in the basement, two shoeboxes full of new "AA" batteries, six flashlights, a couple of first-aid kits, a pile of wood for the fireplace, two dozen cans of soup and other assorted food we'll never eat. So, even if the supermarket doors slam shut at midnight, December 31, we're prepared.

I can't help wondering if other folks are doing the same or if we're the only ones who'll end up over-watering the African Violets in a couple of months and going to the emergency room overdosing on Spam!

Still, the American Red Cross is urging everyone to be prepared. They even printed a pamphlet titled "Y2K — What You Should Know." It's pretty informative and probably has the best explanation of Y2K I've read. The pamphlet also says, in part, ". . . the good news is that federal, state, and local governments; banks and other financial institutions; retail businesses, and every other group affected by this problem has been working to resolve it, and a great deal of progress has been made."

Uh, oh. I smell something burning again and it smells mighty fishy. Don't get me wrong. I *like* the Red Cross. They do tons of super work. Really. But when someone tells me that "every other group affected by this problem have been working to resolve it . . ." my horsehockey meter goes off scale.

Every TV program and article I've read about Y2K and the potential wide spread problems that may occur on January 1, 2000 hasn't said anything about the

(Continued on page 77)

POPULAR COMMUNICATIONS

EDITORIAL STAFF

Harold Ort, N2RLL, SSB-596, Editor

(Internet e-mail: PopularCom@aol.com)

Tom Kneitel, K2AES/SSB-13, Senior Editor

(Internet e-mail: K2AES@juno.com)

Edith Lennon, N2ZRW, Managing Editor

Alycia Nichol森, Assistant Editor

Richard S. Moseson, W2VU, Online Coordinator

(Internet e-mail: W2VU@amsat.org)

CONTRIBUTING EDITORS

Richard "RD" Baker, Utility Communications

Ed Barnat, TCA-44, CB SSB

Peter J. Bertini, K1ZJH, Restoration/Electronics

Joe Carr, K4IPV, Antennas

Bruce Conti, AM/FM Broadcasts

Joseph Cooper, Projects and Broadcast Band

Gerry L. Dexter, Shortwave Broadcast

Alan Dixon, Legislative Affairs

Jock Elliott, SSB-734, Citizens Band

Eric Force, Radio and the Internet

Kirk Kleinschmidt, NT8Z, Amateur Radio

Ian Poole, SW Broadcasting

Bill Price, N3AVY, Humor/Communications

Ken Reiss, Technical/Scanning

Edward Teach, Pirate and Alternative Radio

J.T. Ward, Scanning

Gordon West, WB6NOA, Radio Resources

BUSINESS STAFF

Richard A. Ross, K2MGA, Publisher

Donald R. Allen, W9CW, Advertising Mgr.

Emily Leary, Sales Assistant

Sal Del Grosso, Accounting Manager

Ann Marie DeMeo, Accounting Department

Judith Erickson, Office Manager

Catherine Ross, Circulation Manager

Melissa Gilligan, Operations Manager

Denise Kells, Data Processing

PRODUCTION STAFF

Elizabeth Ryan, Art Director

Barbara McGowan, Associate Art Director

Edmond Pesonen, Electronic Comp. Mgr.

Dorothy Kehrwieler, Production Manager

Emily Leary, Assistant Production Manager

Hal Keith, Technical Illustrator

Larry Mulvehill, WB2ZPI, Photographer

A publication of



CQ Communications, Inc.
25 Newbridge Road
Hicksville, NY 11801-2953 USA

Office: 25 Newbridge, Hicksville, NY 11801. Telephone 516-681-2922. Popular Communications (ISSN-0733-3315) is published monthly by CQ Communications, Inc. Periodical postage paid at Hicksville, NY and additional offices. Statement of Ownership, Management and Circulation, October 1, 1999. Popular Communications, 25 Newbridge Road, Hicksville, NY 11801. Publication #0733-3315. Issued monthly, subscription price \$25.95 per year (12 issues). Publisher: Richard A. Ross; Editor: Harold Ort, owned by CQ Communications, Inc. Stockholder: Richard A. Ross. Circulation (Average of Preceding 12 Months): Net Press Run 58,207. Sales Through Dealers and News Agents 23,102. Mail Subscriptions 17,080 Total Paid 40,182. Free Distribution 752. Total Distribution 40,934 Copies Not Distributed 1,550. Returns from News Agents 15,723. Total 58,207. Circulation (single issue nearest filing date): 51,306. Sales Through Dealers and News Agents 20,668. Mail Subscriptions 16,265. Total Paid 36,933. Free Distribution 750. Total Distribution 37,683 Copies Not Distributed 956. Returns from News Agents 12,667. Total 51,306.s/Richard A. Ross, Publisher. Entire contents copyrighted 1998 by CQ Communications, Inc. Postmaster: Please send change of address to Popular Communications, 25 Newbridge Road, Hicksville, NY 11801.

BY HAROLD ORT, N2RLL, SSB-596

NEW

CATCH IT. HOLD IT. TUNE IT.

Tuning your receiver will never be easier. Introducing the all new Mini Scout Reaction Tuner. With a .001 second measurement time, the Mini Scout will not miss even the briefest of transmissions. While

locking onto a frequency from up to 200 feet away (5w UHF), the Mini Scout automatically tunes the receiver* to the action using its patented Reaction Tune capability. No manual tuning necessary.

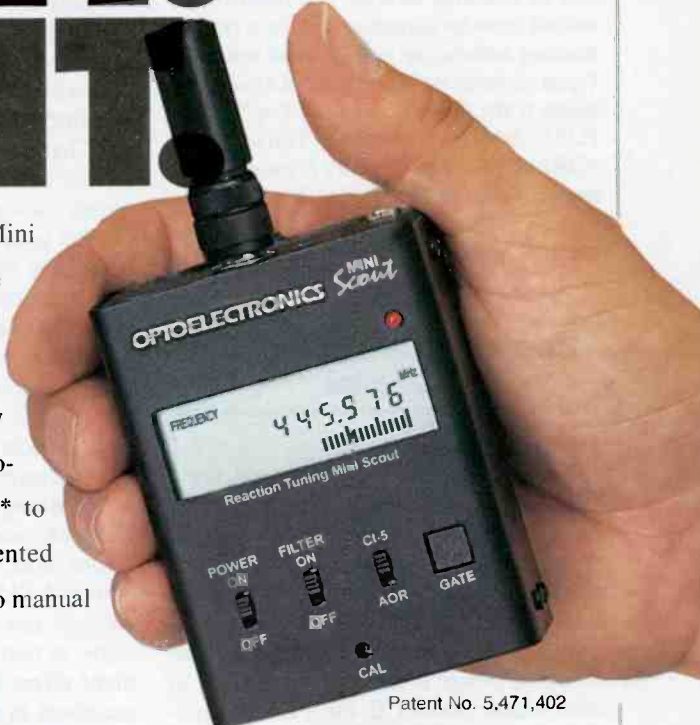

Patent No. 5,471,402

***Compatible Receivers:**

ICOM
7C00, 7100, 8500, 9000, R10
AOR
8000, 8000B, 8200
Optoelectronics
Optocom, R11
Radio Shack
Pro2005/6 with OS456/Lite
Pro 2035/42 with OS535

No modifications necessary. Interface cables required.

Specifications	Scout	Mini Scout
10MHz - 1.4GHz	•	•
Reaction Tune	•	•
LCD Display	•	•
<5mV Sensitivity	•	•
Signal Strength Bargraph	•	•
Filter Mode	•	•
Capture Mode	•	•
Backlight	•	•
Beeper	•	•
Vibrator	•	•
430 Memories	•	•



Patent No. 5,471,402 AR8200 Not Included

**Scout Frequency Recorder
Reaction Tuner**
\$349

**Mini Scout
Reaction Tuner**

\$249



SPECIAL
DB32 & CC30 \$29

Place your Order anytime at the Optoelectronics Cyber Store www.optoelectronics.com



Are FM Broadcast signals a Problem?
Knock them out with the N100 Notch Filter. Blocks 88 - 108MHz, Connect between antenna and Scout or Mini Scout.....**\$99**

OPTODIRECT • 800-327-5912
OPTOELECTRONICS®

5821 NE 14th Avenue • Ft. Lauderdale, FL 33334
Phone: (954)-771-2050 Fax: (954)-771-2052 E Mail: sales@optoelectronics.com
Prices and Specifications are subject to change without notice or obligation.
DB32 Antenna shown on Scout and Mini Scout sold separately. AOR, ICOM, Radio Shack are all registered trademarks

OUR readers SPEAK OUT...

Each month, we select representative reader letters for our "Pop'Comm P.O." column. We reserve the right to condense lengthy letters for space reasons and to edit to conform to style. All letters submitted must be signed and show a return mailing address or valid E-mail address. Upon request, we will withhold a sender's name if the letter is used in "Pop'Comm P.O." Address letters to: Harold Ort, N2RLL, SSB-596, Editor, *Popular Communications*, 25 Newbridge Road, Hicksville, NY 11801-2909, or send E-mail via the Internet to <popularcom@aol.com>.

Licensing CB? Go For The Cellular

Dear Editor:

I agree with the FCC for requiring a license to use CB radios but with some conditions. They probably have to expand to more than 40 channels because it is a waste of money, time, and effort to just get a license to operate a 40-channel CB. It isn't worth it, unless there are more channels and power is increased. I am not so enthusiastic about CB, but I use it sometimes. If the FCC did this, I would have to forget it entirely and opt for something else, such as a cellular phone. Thanks.

Theng Khien
Stockton, CA

Weighing In On REACT

Dear Editor:

The "Giving Up The Ship" (October *Pop'Comm*) illustrates that it takes a hardy soul to continue monitoring CB Channel 9 in many areas of the U.S. Yes, there is skip, excessive power, improper use, foreign language, as well as inadequate enforcement and self-policing. At the same time, there is a significant drop in Channel 9 users, as I can personally verify after recently driving over 10,000 miles around the country. All these factors make it a real challenge to continue monitoring and obtaining new members for REACT. This situation received top attention at our annual convention last July. Immediately afterwards, a news

media release was issued concerning a membership drive, with information going to many magazines including *Popular Communications*.

Many successful teams have faced the reality that CB, and Channel 9, will probably never return to what we knew years ago when it was viable. So now, they monitor other frequencies in addition to CB Channel 9, rather than just give up the idea of assisting the public through volunteer two-way radio communications. GMRS is in heavy use on the assistance frequency of 462.675 MHz, two-meter ham frequencies are monitored by our increasing amount of licensed amateurs, and there are a surprising number of teams even listening to VHF marine frequencies — not only along the coastal areas, such as Suburban REACT in Massachusetts or Kitsap County REACT in Washington, but such places as Kentucky and Utah.

Our work continues, although we use new and additional radio "tools" just as we now use a Website, <www.reactintl.org>, as part of the membership recruitment effort instead of waiting for new members to come to us. The mission of monitoring has not stopped, only changed. Don't "give up on REACT."

The ship is only steering a new course and all hands are needed on deck. For information, contact our homeport at 5210 Auth Road, #403, Suitland, MD 20746, phone 301-316-2900.

Bob Leef
Public Relations Co-Chair
REACT International, Inc.

REACT Is NOT Falling Apart!

Dear Editor:

I would like to see the following in your magazine, in the "Our Readers Speak Out." I recently read a letter in the October '99 issue of *Pop'Comm* written by Mr. Donald N. Aspinall of Virginia. In that letter, he stated that "REACT is falling apart." Well, maybe your team is falling apart, but that is an unfair and untrue statement. I mean no disrespect by this, but there are still an awful lot of very active REACT chapters out there, and

they are very busy. Our Chapter, Bay County REACT 3301 Inc., was chartered in 1976 and has been extremely busy ever since. We found out a long time ago that there is a lot more to REACT than just monitoring Channel 9. Yes, it is true that there is a lot of "skip" that interferes, and there are loudmouths on other channels that bleed over several channels. If you are familiar with Solar cycle 23 (an 11-year cycle, where "skip" is at its strongest and weakest), then you know that in the year 2000 it will peak out and then be on the down-side for another 11 years.

What else can REACT do to be of public service? Our Chapter works with all of the local law enforcement agencies and other emergency organizations on several types of emergencies, such as major fires, floods, snow storms, wind storms, and even "mock disasters" to train new people. Our members are current in adult, child, and infant CPR, and first aid. We sponsor "awake breaks," and at "Operation CARE" we work with the local runners club on all of their races, we do communications for many different organizations in our town. One of our "pet projects" is transportation of human organs for transplant. Each trip is several hundred miles and we are nearing 1,200 trips.

I could go on but I know the space is limited. So you see, Mr. Aspinall, REACT is not falling apart, there are just some chapters that have not branched out into public service far enough. There is plenty to do out there, and we are here to do it. And frankly, we are quite proud of what we do here in Bay City, Michigan.

Jack Oslund
County Director
Bay County REACT 3301 Inc.

Dear Jack:

Thanks for bringing your REACT group's activities to our attention. And congratulations on doing such an excellent job of working in your community. I encourage other REACT teams to contact us about their activities — send along some photos. Let's do whatever it takes to publicize your efforts — and don't forget to invite your local media to these community events!

FREE DSP

Limited time offer. See dealer for details.



IC-R75 Full out the weak signals. Cutting edge technology for today's serious DX listener, yet easy and affordable for a casual listener. 0.03 - 60.0 MHz; commercial grade; all mode; synchronous AM detection (S-AM); optional DSP; triple conversion; auto notch filter; twin passband tuning (PBT); large front mounted speaker; large display; well spaced keys and dials; 1000 memory channels; up to two optional filters; PC remote control with ICOM software for Windows®.



IC-R8500 The expert's choice. 0.5 - 2000 MHz; commercial grade; all mode; 1F shift; noise blanker, audio peak filter (APF); 1000 memory channels; built-in CI-V command control and RS-232C port for PC remote control with ICOM software for Windows®.

"If you want a receiver that is both a superior world band radio and a solid scanner, the new Icom IC-R8500 is the best choice."

- *Passport to World Band Radio, 1998*

FREE PERCON CD ROM

Limited time offer. See dealer for details.



Computer not included

IC-PCR1000
The original "World in a Little Black Box". 100% PC hardware external. Impressive 0.01 - 1300 MHz wide band reception, all modes. Listen to your favorite broadcasts while working in foreground applications. Designed for Windows® 3.1 or 95.

"The PCR1000 has something to intrigue and satisfy everyone. This is a fun product." - *QST, 7/98*

ICOM brings you the **BEST** in wide band receivers

IC-PCR100 A little different look, a little fewer features, a little lower price. Enjoy wide band 0.01 - 1300 MHz reception on AM, FM and WFM. Outstanding performance. Designed for Windows® 95 or 98. Download and demo the software today: <www.icomamerica.com>



Computer not included.

SAVE \$50

Limited time offer. See dealer for details.



IC-R10 (below) Advanced performance and features. 0.5 - 1300 MHz; all mode; alphanumeric backlit display; attenuator; 7 different scan modes; beginner mode; band scope; 1000 memory channels; comes with 2 AA Ni-Cds and charger.

SAVE \$50

FREE SOFTWARE

Limited time offer. See dealer for details.

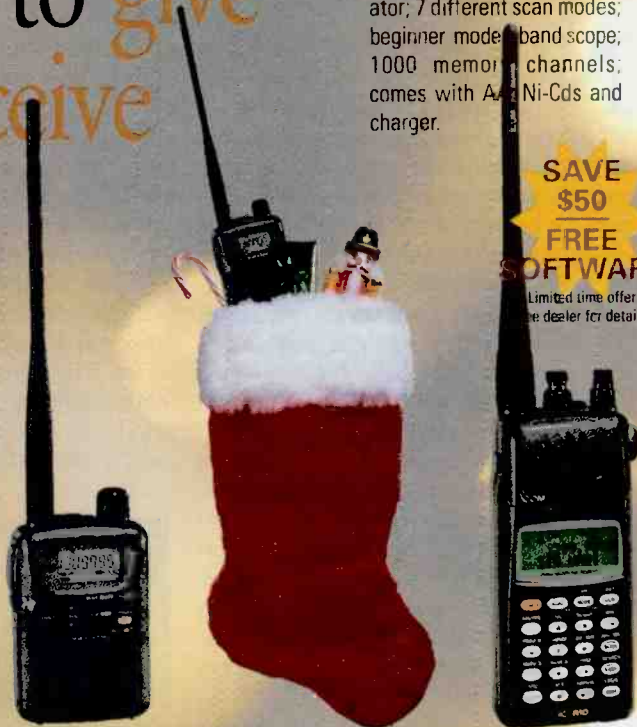

IC-R2 (above, left) Excellent audio, tiny package.

0.5 - 1300 MHz; AM, FM, WFM; easy band switching; CTCSS decode; 400 memory channels; large internal speaker; priority watch; auto power off; MIL SPEC 810 C/D/E (shock/vibration); weather resistant; includes 2 AA Ni-Cds and charger.

Contact an authorized ICOM dealer today, or call for a free brochure: 425-450-6088



ICOM

www.icomamerica.com

*Cellular frequencies blocked; unblocked versions available only to FCC approved users. ©1999 ICOM America, Inc. 238D 116th Ave NE, Bellevue, WA 98004 • 425-450-6088 The ICOM logo is a registered trademark of ICOM, Inc. Questions? Contact your authorized ICOM dealer, or contact ICOM America Tech Support through the HamNet forum on CompuServe® at 75540.525 (e-mail: 75540.525@compuserve.com) All specifications subject to change without notice or obligation. CompuServe is a registered trademark of CompuServe, Inc. Windows is a registered trademark of Microsoft Corporation. RCVR/FAM/PGP1099



Millennium? Don't Celebrate Here!

Checking Out The World's Hot Spots From The Comfort Of Home

By Gerry L. Dexter

No one has a better feel for how dangerous this globe is than shortwave DXers and SWLs, whose monitoring regularly brings news of wars, revolutions, massacres, assassinations, and other modes of mayhem created by both man and nature. Indeed, at any one time, there are a couple of dozen or so countries around the world suffering from at least a low level insurgency. There are a lot of places you wouldn't be eager to visit, and quite a few which the U. S. Department of State actually warns U.S. citizens against visiting.

A number of the countries currently on the list have shortwave stations, so, in theory, at least, we can travel there by shortwave. "In theory" because a high percentage of the troubled countries which have shortwave outlets are on the air using poor, weak, or very limited facilities. That makes catching them extremely difficult.

That said — and at the risk of appearing insensitive to foreign plights, let's take a look at those "shortwave" countries on the "don't go there" list and consider when and where to tune to try and pick them up. Keep in mind that, as with everything in shortwave, the only thing you can count on is change — including frequencies, times, and even the active/inactive status of stations.

AFGHANISTAN — Various guerrilla groups have fought several governments on a near non-stop basis here since even before the Soviet Union created its

own Vietnam in Afghanistan. Other things that would make you uneasy are the several million land mines just under the surface of the ground and the fact that big time terrorist Usama Bin Laden has his base here and has a decided dislike for Americans. There's no U.S. representation of any kind in Afghanistan.

Each of the two main factions in Afghanistan has a shortwave station, neither one is any Deutsche Welle, power-wise. The hard line Taliban fundamentalists operate the **Voice of Shari'ah** (Voice of Islamic Law) — on **7200** (formerly 7088) from 1230 to past 1700 and

then reopening at around 0125. Programs are mainly in the Pushtu language, but there are also some brief English language newscasts and IDs.

The opposition, anti-Taliban station is **Takhar Radio**, which broadcasts in Dari and Pushto from 1300 to 1415 and 0130 to 0245 on **7070**, sometimes **7085**. Both shortwave stations use quite low power and are heard in North America with great difficulty.

BOSNIA-HERZEGOVINA — Although the war here has ended, the State Department says the area is still extremely dangerous, thanks to occa-



A QSL card from the Pakistan Broadcasting Corporation.

Visit

www.winradio.com

A whole new world of radio.

An amazing Christmas special!



Award-winning* WR-1000i Receiver



Waterfall Scanner Plug-in



Hit counter Plug-in



Memory Manager



Watchdog Plug-in



Micropanel Plug-in



Timer Plug-in

All for only \$349** from:

Advanced Digital Systems

of Saint Louis, Inc.



Communications & Security Division

Where Technology & Ingenuity Meet...

Email: winradio@advdig.com

Phone: (636) 458-1100

Fax: (636) 458-1597

1374 Clarkson/Clayton Center, St. Louis, MO 63011

CIRCLE 151 ON READER SERVICE CARD

* *The Most Innovative Receiver of the Year by WRTH.*

** *Add only \$99 for the Trunking Option, the most affordable way of getting into computer-based trunk tracking!!!*

sional localized political violence, unexploded military ordinance, carjackings, and other violent crime. This is especially so in the Republikd Srpska area.

Radio TV Bosnia-Hercegovine operates from Sarajevo on **7102.5 upper sideband** 24-hours a day. Your best bet is in the evening.

ALBANIA — The Department says the security situation here is “unstable.” Many Albanians lost everything in what turned out to be a government-approved Ponzi scheme a couple of years ago. An unstable political situation, coupled with the huge influx of refugees from Kosovo keeps the overall situation there very shaky. The U.S. Embassy in Tirana has cut its staff to the bone and can offer only emergency help.

The government’s **Radio Tirana** is fairly easy to hear. The station has an English-language service to North America, albeit not quite as extensive as it once was. Check **6115** (sometimes **6120**) and **7160** at 0145 to 0200 and again from 0230 to 0300.

ALGERIA — Algeria has been in a state of emergency since 1992 and killings by anti-government guerrillas have climbed into the thousands, including more than 100 foreigners. You’re advised to stay only in the larger hotels which offer security and not to travel without “substantial armed protection.”

Radio Algiers can be heard at various times, though not necessarily on every attempt. Higher frequencies during the daytime hours usually do best. Check **9535** from 1600 to 1900, **9640** from 2200–0000, **11715** from 1200 to 1900, **15160** from 1000 to 1500 and 1800 to 2000, **15205** from 1200–1600 and 1700–2000, **15215** from 2200–0000, **17745** at 1500–1900. Radio Algiers has English broadcasts from 1600–1700 and 2000–2100 on **11715** and **15160**. The station airs Spanish programming from 1700–1800 on 11715 and 15160, and 1900 to 2000 on 11715.

ANGOLA — An on-again, off-again civil war that dates back to Cold War years continues here, with the UNITA forces of Jonas Savimbi alternately taking it to, and taking it from the government, with an occasional soon-to-be history peace treaty tossed in now and then. On top of that, there are bandits, military, and police personnel who are doing their own thing.

The government station, **Radio Nacional**, broadcasts on **4950** (slightly variable) and **11955** (ditto). Best times are late afternoons and on into the evening

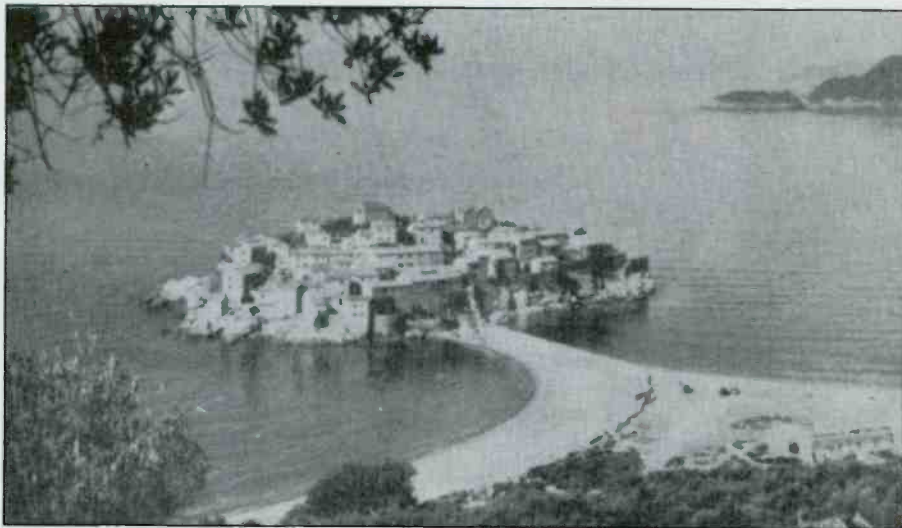

A Radio Yugoslavia QSL. The station is still on the air despite heavy U.S. bombing.

hours. Our winter season makes **4950** more likely late in the evening.

UNITA has its own station, **VORGAN (Voice Resistencia do Galo Negro)**, which is on the air on **5950** between 0700 and 0900, **7100** from 1900 to 2100, and **11830** from 1200 to 1430. VORGAN is seldom heard these days.

BURUNDI — This country is located next door to Rwanda, scene of the horrendous Hutu/Tutsi killings a couple of years ago. The same ethnic mix is present in Burundi and experts fear a repeat could happen here. There are rebel groups roaming the interior.

Trying to hear the government station, **La Voix de la Revolution**, is going to hurt your teeth. The station uses **6140** from 0200 to 0700 and again from 0900 to 2100 (although there are a few brief breaks in the transmission here and there). 6140 is a busy spot and the signal from Bujumbura hardly ever shows. It’s even possible the station may be off the air. The programming is in French.

CENTRAL AFRICAN REPUBLIC — There’s a high level of crime and highway banditry going on in the CAF and travel outside the capital, Bangui, is not advised, especially at night. There have been three military mutinies here since 1996.

Radio Centrafrique, the government’s station, operates on **5035** from 0430 to 0730 and on a halfway decent night, African reception is a pretty easy pick. (It also uses this frequency from 1700 to 2100). Another transmission runs from 0700 to 1630 on **7220**. Broadcasts are in French.

Radio Minorca, a UN-operated station

set up to try and calm things down, may have run its set course by the time you read this; it was scheduled to close on November 15, 1999, but personnel there were trying to get an extension. If they suc-

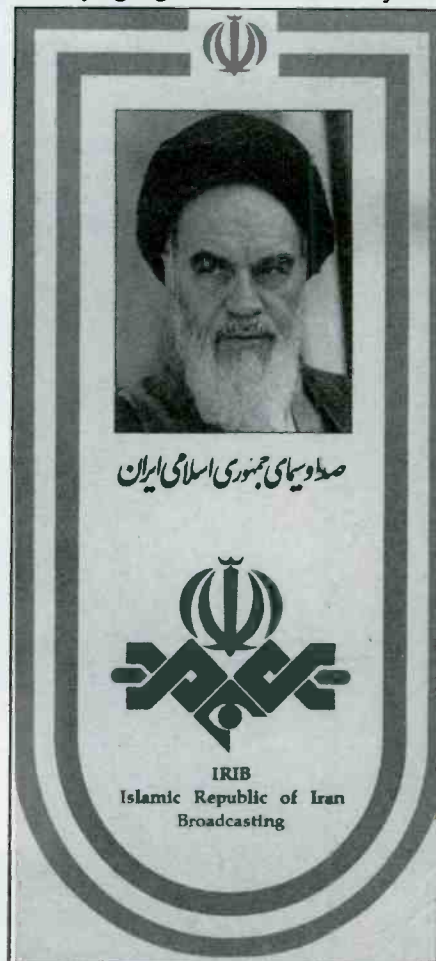

The old boy is still doing his thing on Iran’s shortwave voice. Try 9022 at 0030 UTC.

Passport to World Band Radio

World's #1 selling shortwave publication

Unparalleled news and perspectives, plus every sort of music and diversion. That's world band radio, from as many as 165 countries.

The New York Times calls *Passport to World Band Radio* the "TV Guide for world band radios," and no wonder. *Passport* is jammed with just what you need to eavesdrop on our world: Best and worst radios. What shows are on. Tips from the world's leading experts.

With *Passport*, you'll have the world at your fingertips.

"Shortwave is as close to magic as you can get without a bag full of salamanders."

—*The Atlanta Journal-Constitution*

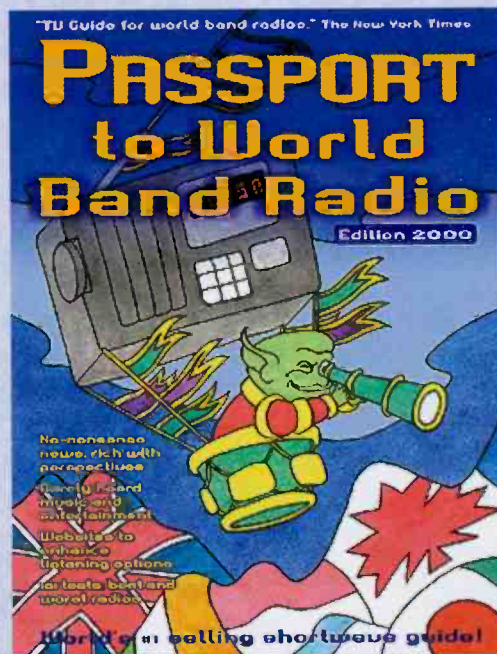

\$19.95 each at bookstores everywhere, or contact:

International Broadcasting Services, Ltd.

Box 300, Penn's Park, PA 18943

www.passband.com • (215)598-9018 • mktg@passband.com

Distributed to the book trade by National Book Network (800)462-6420

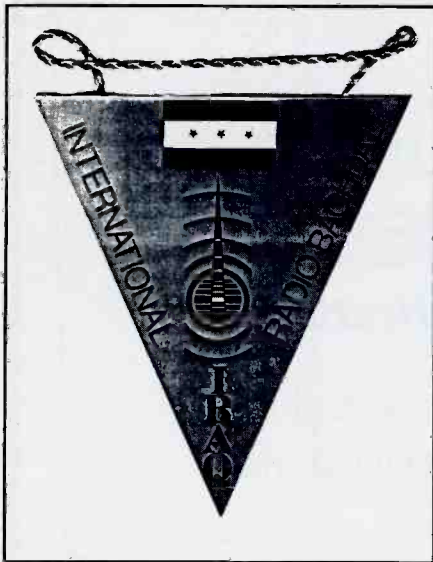

A pennant from Radio Baghdad, Iraq.

Department says the risk of being kidnapped is higher in Colombia than anywhere else in the world. And U.S. military advisers are now in the country, trying to assist in the anti-drug wars. There's a pretty good list of Colombian stations you can go after:

When active, **La Voz del Cinaruco**, in Arauca, is on **4865**. Try at 0900 sign-on or in the evenings.

Ondas del Meta, Villavicencio, operates from 1100-0500 on **4885**.

Armonias del Caqueta, in Florencia, uses variable **4915** from 1000-0300.

Radio Nacional, the government station from Bogota, is on **4955** and operates from 0900 to 0500. Well heard most evenings, they air a classical music format.

Ondas del Orteguezza, Florencia, is on **4975** from 1200 to 2300, but sometimes runs into the evenings. When it does so, and when the nasty utility transmission usually on that spot isn't there, they should come through.

Ecos del Atrato, Quibdo, uses variable **5020** from 1000 to 0400.

An easy pick is **Caracol Colombia**, Bogota, on **5077**, running 24-hours a day.

Caracol Villavicencio uses **5955** from 0900-0500.

La Voz de Guaviare, in San Jose del guaviare, is on **6035** from 1130 to 0200.

La Voz del Llano, Villavicencio, is on variable **6115** from 0900 to 0400.

Caracol Florencia uses variable **6170** 24-hours a day.

Both of the guerrilla organizations have (or had) stations. ELN's **Radio Patria Libre** is active on **6250** with broadcasts from 1800 and 2200.

FARC's La Voz de Resistencia is also hard to hear. The most recent schedule has it active with broadcasts at 1100, 1300, 1700, 2000, and 2130 on variable **6170** and 1130, 1800 and 2000 on **6240**.

REPUBLIC OF THE CONGO —

The most recent war ended in late 1997, but there are still skirmishes between various paramilitary groups and government forces. English-speaking people or those who are thought to be part of military or missionary organizations have been targeted for arrest or other harassment. This, to put it mildly, is not a good place to be.

The government's Radiodifusion National Congolaise, also known as **Radio Congo**, operates irregularly and even when on, it's a difficult catch. Try **5985** between 0430 and 0700 and 1600 to 2130 (best chance is close to this sign-off time). It's also supposed to be active on **9610** from 0430 to 0700.

ERITREA — Eritrea and Ethiopia, of which it was once a part, have been fighting over a disputed border area. And despite a recently signed treaty, the border with the Sudan is also tense. There are also terrorist groups active, including the Eritrean Islamic Salvation organization.

The government station (once a clandestine) is the **Voice of the Broad Masses of Eritrea**, which operates on **7175** from 0330 to 0430 in Arabic and 0430 to 0530 in Amharic.

Radio Fana, on **6940** from 0330-0530, 9000-1100, and 1500-1700, is sponsored by educational groups.

Two clandestines are active: **The Voice of Truth**, operated by the Islamic Salvation Movement, on **8020** from 1430 to 1530 in the Tigrigna language. Also the **Voice of Democratic Eritrea — Voice of the Eritrean Front Revolutionary Council**, uses **8020**, at 1400-1430. Both use broadcast facilities supplied by Sudan.

ETHIOPIA — The story in this area is essentially the same as with Eritrea. There are also problems in the Tigray region, which seeks independence, as well as the Oromo region.

The Voice of Ethiopia is active on **7110** from 0330 to 0600 (Sundays from 0400 to 0900) with programming in Amharic.

Rainbow Radio — The Voice of Peace and Brotherhood is a program aired via German government transmitters. It's produced by the Research and Action Group for Peace in Ethiopia and the Horn of Africa and airs Saturdays from 0100-0200

ceeded, you may be able to pick up the station on **9900**, operating around the clock.

COLOMBIA — In a word: drugs. Two guerrilla forces active here are mostly about drugs. And one group, the Revolutionary Armed Forces of Colombia (FARC) now controls large sections of the country. Both groups (the National Liberation Army — ELN is the other) have been declared as terrorist groups by the U.S. government. The State

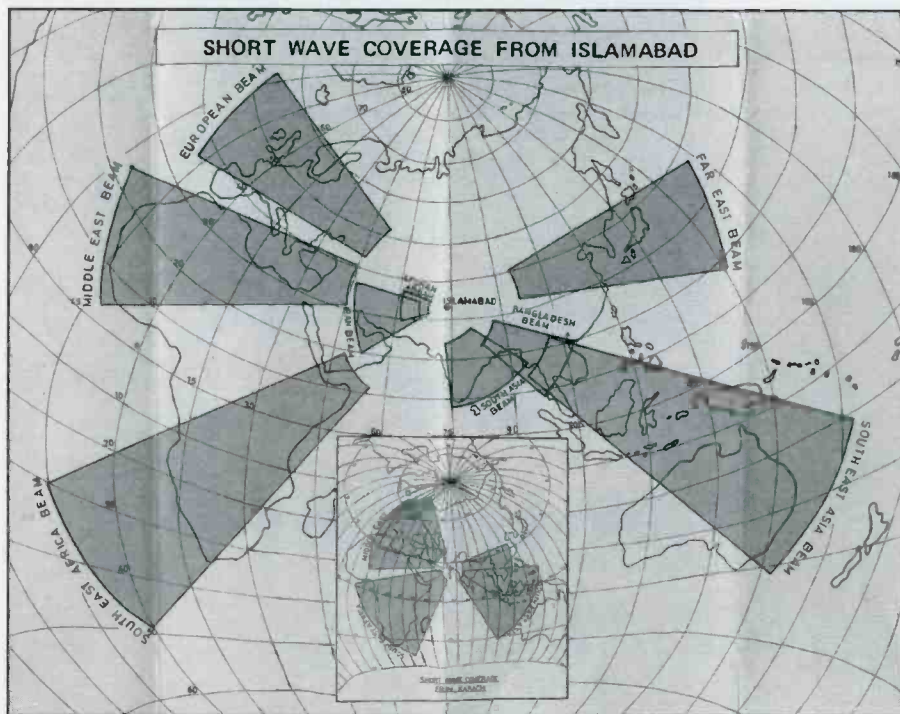

A look at Pakistan's shortwave coverage map.



A 1976 souvenir from Albania.

on **9855**, Sundays 0900–1000 on **5995**, and Thursdays, 1600–1700 on **15105**.

IRAN — There are a lot of people in and out of government who intensely dislike Americans, even though things are lightening up a little. The U.S. still does not have diplomatic relations with Tehran. If you happen to be Iranian-American, you're especially subject to harassment and detention — even execution if you've converted from Islam or are a non-Muslim who has encouraged Muslims to convert.

The Voice of the Islamic Republic of Iran has an extensive shortwave broadcast schedule. Here's the English portion: 0030 to 0130 on **9022, 9795, and 11970**; 1100–1230 on **13710, 15255, 15430, 17560, and 21510**; 1530 to 1630 on **11680, 13605, and 15150** and 1930 to 2030 on **9022 and 9880**.

IRAQ — Need we say more? **Republic of Iraq Radio or Voice of the Iraqi Republic** was essentially destroyed in the Gulf War and is still just an echo of what it once was. Operation is irregular but it most often appears on **11787** from 0200 to 0500 and 2000 to 2300 with programs mostly in Arabic. Reception is only fair, at best.

LEBANON — Americans are all too frequent targets for attack here. The Hizballah terrorist organization is active, there are around 25,000 Syrian troops, and Israel maintains a "security zone" in the south.

Two stations are active in Lebanon. **The Voice of Hope**, a station of the High Adventure Ministries group based in

California, operates 24-hours-a-day on **6280 and 11530**. **The Radio Voice of Lebanon** is on around the clock on **6550** and is best heard in the evening.

LIBERIA — Fighting in the fall of 1998 made worse an already bad situation. And, even though things in the capital, Monrovia, are improving at present, many government military and security personnel are untrained and probably unreliable. Rebel activity in Sierra Leone is affecting security along the border. The crime rate is extremely high, particularly against foreigners.

Radio Liberia International is active (more or less) with broadcasts in English on **5100** from 0500 to 0800 and again from 1800 to 0000.

Star Radio, operated by Liberian journalists, managed by a Swiss foundation with assistance from the U.S. Agency for International Development, is an on and off proposition, since it has had a couple of run-ins with the Liberian government. When active, it uses **3400 and 5890** from 0500 to 2000.

LIBYA — There's no U.S. Embassy here, but you probably knew or guessed that. Washington and Colonel Qaddafi haven't exactly kissed and made up. Foreign visitors are often put under surveillance, phone calls may be monitored, and your hotel room searched while you're out. Financial and commercial transactions with Libya by U.S. citizens are against the law unless licensed by the Treasury Department.

Radio Jamahiriya operates on **15235, 15395, 15415, and 15435**, although at

this writing, some of the frequencies seem inactive. Broadcasts run from 1045 to 1230 and (better for us) 1645 to 0400. There is a brief "Voice of Africa" segment in English at various times on **15415**. It's been noted about 2325 and 0125 and may also air around 2035.

NIGERIA — Civil unrest seems to have reached the level of almost becoming a tradition in this country. A new president was elected in mid-1999, ending several years of military rule. But there is still a lot of violence, crime, kidnapping for ransom. Road travel can be highly dangerous due to the many unauthorized checkpoints set up by armed bands and pseudo police or military groups.

The official **Voice of Nigeria** can usually be caught on **7255**, signing on just before 0500, leading into an English newscast. The international service uses **15120** and airs programs in a number different languages during out local daytime. Reception of this is spotty and it may not be operating consistently.

Two **Radio Nigeria** regional outlets are active — Kaduna on **4770** from 0430 to a bit past 2300, but best heard at 0430. And **Radio Nigeria**, Ibadan, on **6050** from 0430 to just past 2300 — this one best heard closer to its sign-off and during our winter months.

PAKISTAN — Really? The State Department's warning notes that it has increasing evidence that extremists in Afghanistan may attack U.S. interests in Pakistan (and there is public sympathy and support in Pakistan for the terrorist Usama Bin Ladin). In addition, there are various extremist groups active and supporting such causes as the Kashmir/Azad Kashmir disagreements with India. One such group has "banned" travel by all U.S. citizens, even diplomats.

Radio Pakistan airs broadcasts in English at 0230–0245 on **9649, 15485, 17660, and 17895**. Also at 1600 to 1630 (best shot in North America) on **11570, 15320, 15645, 17510, and 17720**. Also in English and Urdu from 0800 to 1120 on **15530 and 17835**.

SERBIA AND MONTENEGRO — The State Department sees a potential for a "high degree of hostility" towards U.S. citizens thanks to our involvement in the NATO war against Serbia over the Kosovo problem. Occasional mass protests are taking place, the infrastructure is badly damaged in some areas, and there are hazards from unexploded ordinance.

The government station, **Radio Yugoslavia**, was knocked off the air during the war, but quickly returned. At pre-

sent, you can hear it best at 0000-0030 and 0430 to 0500 on **9580 and 11850**. Other broadcasts in English are at 1835 to 1900 on **6100 and 9720**; 1900-1930 on **7230** and 2100-2130 on **6100 and 6185**.

SIERRA LEONE — Although the government and the Revolutionary United Front signed a peace agreement last summer, things are still very unsettled. Some military groups have not yet been disarmed and still roam the countryside, as do gangs of bandits. Sometimes, they take hostages. Freetown, the capital, has a strictly enforced curfew running from 9 p.m. to 6 a.m.

The **Sierra Leone Broadcasting Service** operates on **3316** with 10 kW. It signs on the air at 0600 and runs until 1000.

SOMALIA — We're all familiar with the story here. A national government does not exist, simply factions and clans holding territory. Fighting can erupt at any time for any reason. Many of the factions have their own radio stations.

Radio Mogadishu — the Voice of the Somali Republic, which supports "President" Ali Mahdi Muhammad is listed for **6822** between 1600-1800.

Radio Mogadishu — the Voice of the Masses of the Somali Republic, supports Saddam Aidid and is scheduled on

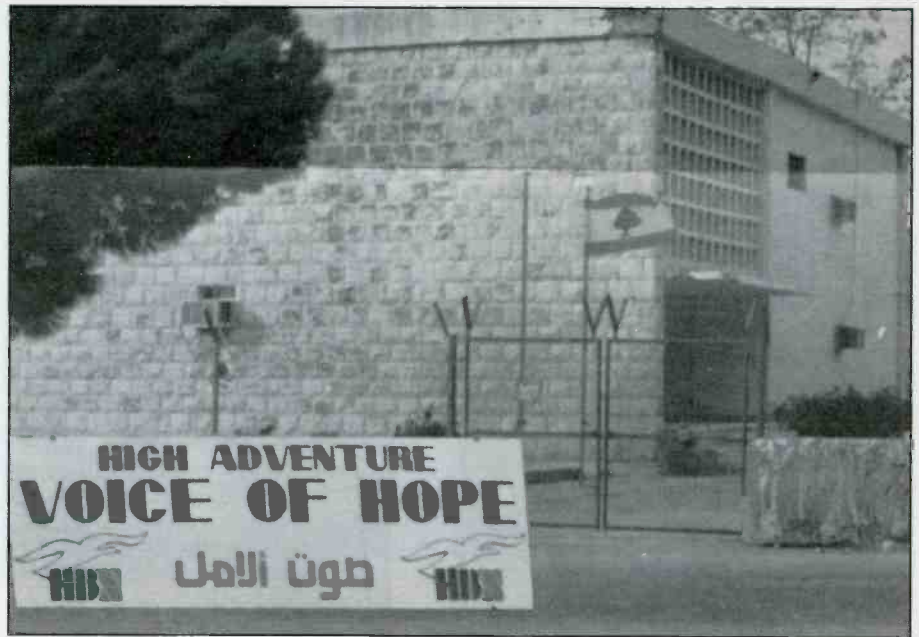

High Adventure Ministries Voice of Hope in Lebanon. They operate 24-hours-a-day on shortwave.

6890 from 0300-0500, 0900-1300, and 1500-1900.

Radio Mogadishu, the Voice of Somali Pacification, supports Osman Ato and is listed for **6732** from 0300-0500, 0930-1200, and 1500-1900.

Holy Koran Radio supports Ahlu Sunnag Waljama is scheduled from 1500 (Fridays 1600) to 1800 on **6545**.

Radio Hargeisa in Northern Somalia is scheduled from 1000-1230 and 1600-1800 and was last heard on **7073**.

SUDAN — Civil war without end is the problem here. The government is fighting a guerrilla force which holds much of the southern part of the country. U.S. citizens are not looked upon with favor, especially after the bombing of what Washington claims was a facility associated with terrorism back in 1998.

The Sudan National Broadcasting Corporation operates on **9200** from around 1245 to 1900 in various languages. Also on **7200** from 1600 to 1900. Lately, both frequency and time adherence have been erratic.

An anti-government station, the **Voice of Democratic Sudan** is active on **8000** (slightly variable) from 0400-0500 and 1600-1800. The government operates a music jammer on or near the clandestine.

TAJIKISTAN — This former Soviet republic is said by the State Department to be dangerous due to its instability. Embassy operations in the capital, Dushambe, were suspended in

September, 1998. There are kidnappings and increased crime. There have been bombings and fighting between various factions and paramilitary gangs.

Tajik Radio in Dushambe operates on **4635** from 0030-1830, **5800** from 2330-0400, **7245** from 0100-0500 and 1400-1800, **7510** from 1630-1800 (highly unlikely for reception here) and **9905** from 0030 to 0430, and from 1630-1800.

REPUBLIC OF YEMEN — Anti-Western terrorist groups have kidnapped people and members of other groups have been arrested for plotting the bombing of Western targets in Yemen. Other terrorist groups continue to operate. Various tribes also kidnap foreigners and there are also carjackings and other security concerns.

Republic of Yemen Radio can, with careful tuning, be picked up on **9780** (it also uses **5950**) with its Arabic language broadcasts, beginning with 0255 sign-on. The schedule runs until 2130 and sometimes the station can be heard both at the beginning and end of its broadcast day.

Again, be advised that situations both within the countries mentioned and with their radio schedules are subject to quick and unannounced change. Let our "Listening Post" column know what you pull in by sending your loggings to *Popular Communications*, 25 Newbridge Road, Hicksville, NY 11801 or visit our Website at <<http://www.popular-communications.com>>, where you can send your loggings via E-mail. ■

Full 800 MHz Scanners
"Cruise the airwaves with your computer!"
ICOM PCR-100-08
Wideband receiver for PC
 - PCR-100 can be used with your Desktop or Portable PC
 - 0.1 to 1300 MHz continuous
 - Modes AM, FM & WFM
 - Built-in tone squelch
 - Multiple screens: multi-function control panel, simple control panel, band scope screen, memory list.
\$199^{us}
"Smallest R-2 wideband scanner!"
 - Compact size, 58 W x 86 H x 27 D mm
 - .5 to 1300 MHz coverage continuous
 - AM, NFM & WFM, 400 memory channels
 - Large internal speaker - Large LCD display
 - Auto squelch system, Auto power-off function
 - Multiple scanning methods
AOR ICOM ALINCO
OPTOELECTRONICS YUPITERU
Guaranteed Delivery to USA.
GRUNDIG "Refurbished"
\$99⁹⁵ us YB-400 Digital Readout!
 - Receives MW-SW-FM - 40 Memories
 - SSB reception - Direct Keypad Entry
 All units comes with leatherette case, original box and manual and a full One Year Warranty parts and labour.
Radioworld
Phone: (416) 667-1000
FAX: (416) 667-9995 Website Address:
 sales@radioworld.ca <http://www.radioworld.ca>
 4335 Steeles Ave. W. Toronto, ON Canada M3N 1V7

THE 2000 WRTH

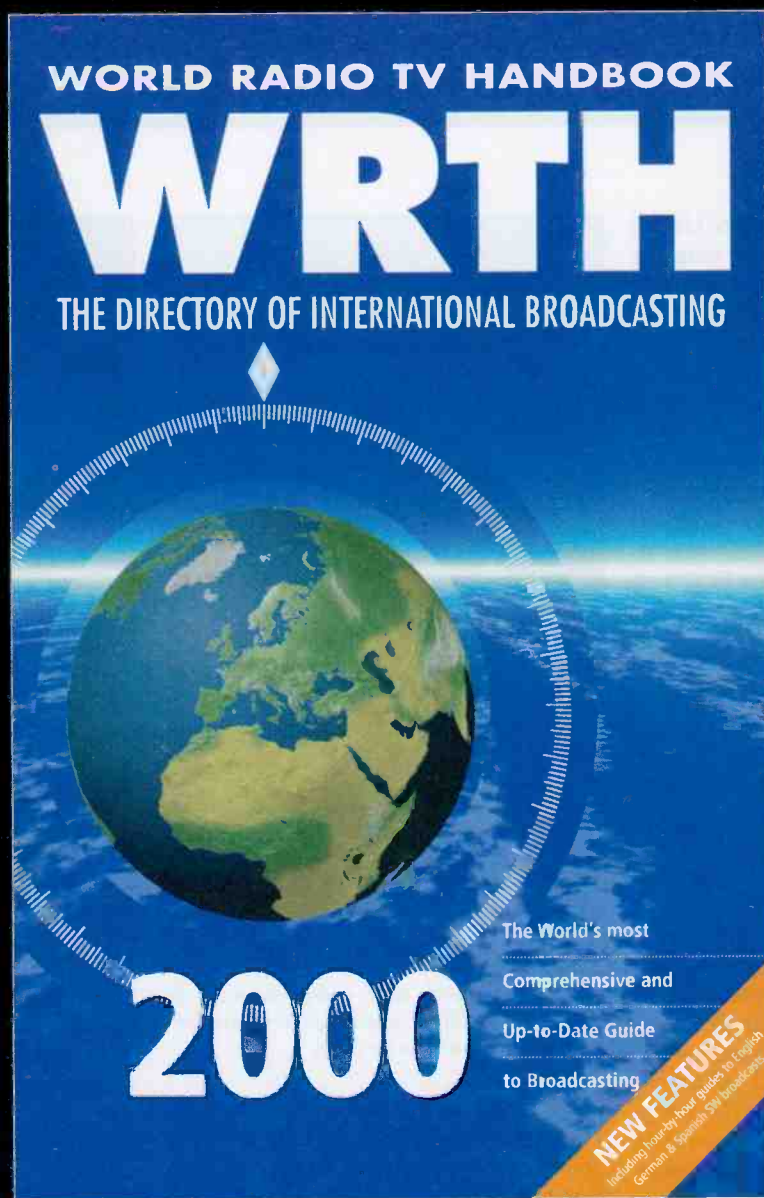

with:

Hour-by-hour guides to international broadcasts in English, Spanish and German

72 pages of color containing color maps

Available at all good bookstores and electronic retailers or contact:
Billboard Books, 1515 Broadway, New York, NY 10036

CIRCLE 129 ON READER SERVICE CARD

The Abominable Dr. Fritz, On The Air!

Was He Hitler's Little Helper Or A Homegrown Hooligan?

By Alice Brannigan

In 1940, with Europe at war, the United States stood on the brink of entering the conflict with Nazi Germany. Network news broadcasts brought audiences here live daily radio reports from correspondents stationed throughout Europe. Our government had become very sensitive to the possibilities of espionage agents and saboteurs within our borders using secret radio transmitters. Because of the tense world situation, American hams had been forbidden to contact overseas stations. The FCC was monitoring the airwaves for violations and for unidentified stations.

Our guess is that the FCC must have totally lost it on April 17, 1941, when an unknown station boldly appeared smack on a frequency of the official FCC monitoring network. Not merely appeared there, but attempted to break in and engage the FCC stations in communications. This was cause for serious concern. A few days later, the same station turned up again, but on 3497.5, 4025, and 6990 kHz, which were active U.S. Army frequencies. The mystery station operator identified himself only as "Fritz" as he attempted to make contact with Army stations, including station WAR, at War Department Headquarters in Washington. The Army was not amused, especially since Fritz generously sprinkled his transmissions with shouts of "Heil Hitler."

Further arousing the interest of monitors was Fritz' "more than average knowledge" of codes and ciphers, and his bragging that he was a cryptographer. Moreover, Fritz said he was a member of an advance unit of The German Army of Occupation. The military stations at first attempted to ignore these transmissions, but Fritz didn't care and even attempted to solicit military information from them. He sent messages he said were intended for foreign agents here. He also played



An FCC patrol unit equipped with a Hallicrafters SX-17 Super Sky rider takes DF bearings on Fritz.

Nazi marches and speeches made by Hitler he had recorded from Berlin's shortwave station. Once, he claimed that powerful transmitters were being built to jam military frequencies. Another time, he sent a lengthy message in cipher. When deciphered, it turned out to be in German and related to certain foreign troop movements.

Quick Reaction

Within four days of Fritz's first transmissions, the government had formulated and implemented its plan of attack. Army stations were encouraged to reply to Fritz



FCC mobile units had DF loops that could be rotated by hand.

and engage him in lengthy conversations. While this was going on, the FCC's Radio Intelligence Division (RID) took direction-finding bearings on the transmitter so that mobile units could be dispatched to his location. Each time he screamed "Heil Hitler" into his microphone, it seemed to make the hunt more intense, adding agents and agencies to the effort.

Army stations attempted to coax Fritz to reveal more about himself and pinpoint his exact location. Upon continually being pressed for such information, he said that his name was Dr. Fritz von Kreiger. He claimed his transmitter was located aboard the German pocket battleship *Admiral Scheer* sailing off the coast of Madagascar. Monitors didn't buy these claims for a minute. They knew Fritz was running an illegal transmitter from within the borders of the United States, more specifically in the Midwest. What they didn't know at that point was what Fritz was up to; whether he was an actual Nazi sympathizer or agent, someone trying to disrupt government comms networks, or simply a crackpot. In any

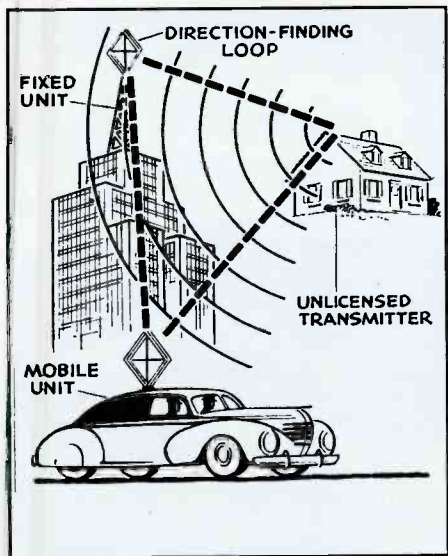

The method used mobile and fixed DF units to locate illegal transmitters during WWII.

event, they wanted to find him and quickly get his station off the air.

Transcripts were made from off-the-air recordings. Here are some actual quotes taken from those transcripts:

“Staff plans are now coming in, but they are very detailed and too long. Too much trouble to re-encipher again.”

“Tell your cryptographer that this is a columnar position.” (This was followed by a lengthy cipher message.)

“I am a cryptographer. You must give me some information in exchange for this stuff. Give me the locations of the following government radio stations: WXLA, WLM, WLH, WLW, WLJ, and WLT. I want your codes and ciphers. Give



Live satellite
weather in
your shack

For as little as \$199.00.*

Swagur Enterprises

P. O. Box 620035

Middleton, WI 53562

Phone/FAX 608-592-7409

Web site swagur.com

email swagur@execpc.com

* using an ICOM™ PCR-1000 or other Receiver

them to me or we will jam your frequencies with our transmitters.”

“Your stations are now in the hands of the enemy. Your insolence will not be tolerated by German troops. This station is operated under the control of the German Signal Corps. You will be in our prison camp. I am the cryptographer for this Signal Corps unit.”

Taken Seriously

Surely, today, such transmissions would immediately be viewed as the ravings of a demented prankster. But in the war-jittery mood of the government at that time, all such matters were viewed with deadly seriousness. By April 21, the FCC's direction-finding efforts had pinpointed the transmissions as coming from the general area of Peoria, Illinois. Furthermore, several high level officials

had been called in to work with the FCC's field staff. Some of those personally involved were United States Commissioner William H. Moore, U.S. Attorney Howard L. Doyle, two U.S. Marshals, as well as Peoria's chief of police.

April 22 found FCC mobile direction-finding units cruising the streets of Peoria. By the following day, they drove along Sheridan Road and stopped near the home of Charles W. Johnson. At that point, they waited while the FBI attempted to check out who Johnson was and what he was all about.

The final day for the station's operation was April 30. While he was engaged in a



Side view of a FCC patrol unit engaged in the search for Fritz. This unit had two Hallicrafters receivers and a recorder that used aluminum alloy discs.



Typical secondary monitoring station used by the FCC's RID.

conversation with an Army station, a task force of federal agents and local police broke into Johnson's home. Though he made a hasty attempt to disable the transmitter, he wasn't able to do so in time. Johnson told them he hadn't meant any harm. He described himself as a senior student in electrical engineering at an area institute.

Arrested on the spot and held on \$2,000 bond, Johnson was promptly brought before a Grand Jury, where he was indicted for violation of Sections 301 and 308 of The Communications Act — and one more of our nation's World War II era mystery stations had bitten the dust.

Business As Usual

Fact is, mystery stations were not all that unusual in the period immediately preceding and during WWII. The FCC's RID vigorously pursued them on the theory that at least some of them were the result of enemy espionage activities. In 1940 alone, a sufficient number of unauthorized transmissions had been monitored to assure our government that their effort was necessary. During one month in 1941, nearly 20 licensed amateur operators were apprehended for unauthorized contacts with overseas stations. In 1943, an East Coast spy ring's transmissions were first picked up by a RID monitor in California. Other monitoring stations were immediately alerted, and mobile units were dispatched to track down the precise location. This led to the FBI's capture and eventual conviction of eight persons on espionage charges.

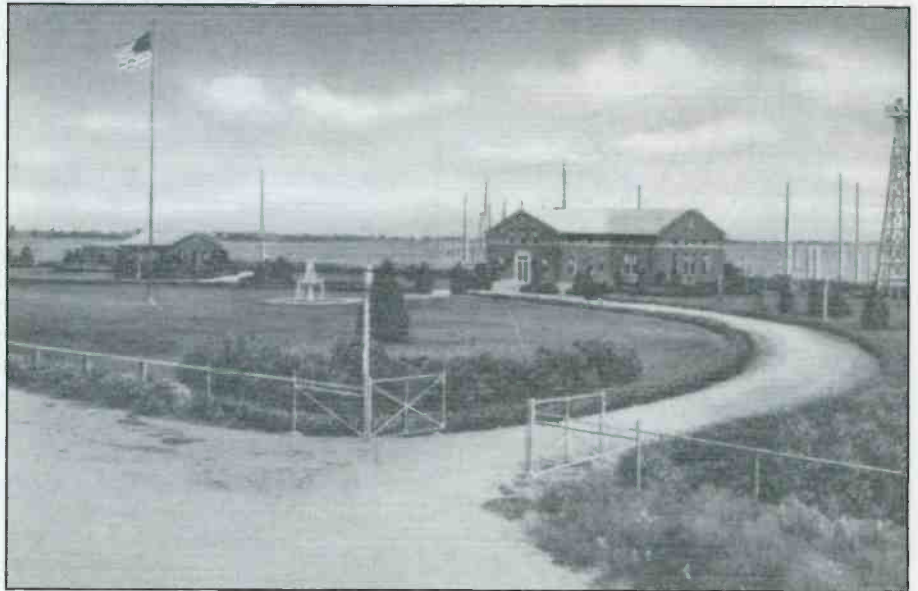

This is the primary FCC monitoring station built at Grand Island, Nebraska.

In the instance of the Dr. Fritz case, it turned out that although Peoria's local ham operators were well aware of the station's activities, little effort was made by those operators to track him down. They apparently felt that it would have proven embarrassing in the event Dr. Fritz happened to be a licensed amateur, or someone studying for a license. As it turned out, he had been neither. In the aftermath of the incident, Peoria area hams were openly scolded in the pages of *QST* magazine (July, 1941 issue) for their reluctance to act. In its August, 1941, issue, *QST* went on to brag about how an earlier, similar Dr. Fritz-type station in Massachusetts was caught because hams

chatted with its operator at length to enable the FCC's RID to zero in on its location with mobile direction finders.

Added Strength

By 1941, when Dr. Fritz was closed down, the FCC had beefed up its monitoring staff from less than 200 to more than 600 engineers and operators. The RID was then employing portable and mobile direction finders, also 59 secondary fixed listening posts located at 200 mile intervals. There were 12 primary long-range DF stations keeping full-time vigil on the airwaves, checking out foreign broadcasts and conversations,

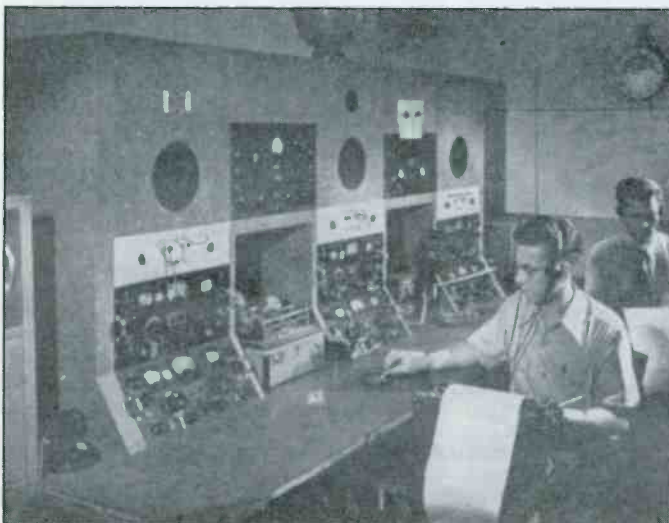

Inside an FCC primary monitoring station.



A federal agent checks out the seized equipment after the raid on Fritz' illegal radio station.

encoded transmissions, and any activities in the radio spectrum that were deemed suspicious or from enemy sources. They also provided emergency direction-finding fixes to locate aircraft lost or crews downed in ocean areas.

“From mid-1940 to the war’s end in 1945, the RID had monitored and shut down many hundreds of unauthorized transmitters.”

The primary monitoring stations were extensive facilities with massive antenna systems occupying large tracts of land. Secondary stations were platform mounted small wooden huts adorned with hand-steerable Adcock direction-finding antenna arrays. All stations had at least one portable direction-finding unit, often installed in a vehicle. Primary and secondary facilities maintained contact with one another, exchanging monitoring data, by landline and radio networks. Although the RID ceased to exist after the war, the FCC has kept some of its primary monitoring facilities in use.

Too Hot To Trot

After actual WWII hostilities stopped, but before the war had officially ended and hams were allowed a return to full privileges, there was unauthorized amateur activity on the part of American military personnel serving overseas. Many eager hams simply fired up their military stations on the 20- and 40-meter bands in order to again enjoy their hobby. The RID reported the call letters of these operators to the Pentagon for action.

From mid-1940 to the war’s end in 1945, the RID had monitored and shut down many hundreds of unauthorized transmitters. These included stations operated by pranksters, cranks, misguided amateurs, as well as actual espionage agents.

Hope you keep in touch. We are always looking for your old time radio QSLs (good photocopies are OK if you can’t spare the originals), station photos and picture postcards, news clippings, and station directories. Please pass them along to us. Our postal address is Alice Brannigan, *Popular Communications*, 25 Newbridge Road, Hicksville, NY 11801. Our direct E-mail address here is: <Radioville@juno.com>. Be with us next month! ■

how I got started

Congratulations To Jerry Bilodeau Of Pittston, Maine!

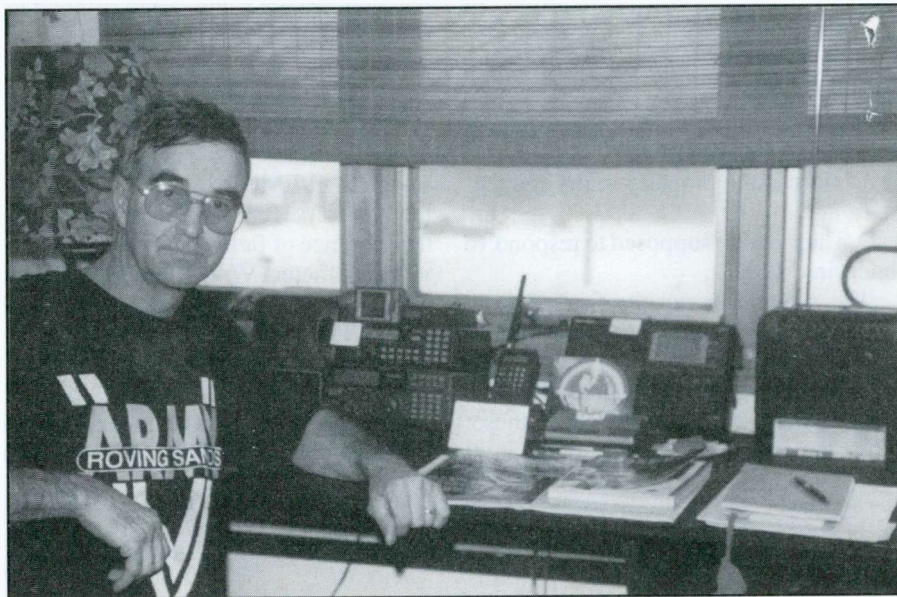

Jerry Bilodeau of Maine in his monitoring post.

Popular Communications invites you to submit, in about 150 words, how you got started in the communications hobby. Entries should be typewritten, or otherwise easily readable. If possible, your photo (no Polaroids, please) should be included.

Each month, we’ll select one entry and publish it here. Submit your entry only once; we’ll keep it on file. All submissions become the property of *Popular Communications*, and none will be acknowledged or returned. Entries will be selected taking into consideration the story they relate, and if it is especially interesting, unusual, or even humorous. We reserve the right to edit all submitted material for length, grammar, and style.

The person whose entry is selected will receive a one-year gift subscription (or one-year subscription extension) to *Popular Communications*. Address all entries to: “How I Got Started,” *Popular Communications*, 25 Newbridge Road, Hicksville, NY 11801 or E-mail your

entry to <popularcom@aol.com>, letting us know if you’re sending photos.

Our January Winner

Pop’Comm reader, Jerry Bilodeau of Pittston, Maine, says, “I started DXing 40-plus years ago using a Zenith Transoceanic (wish I still had it) and then started DXing again when I saw the DX-390 on sale a few years ago. My monitoring post has kept growing ever since.

I recently moved back to the coast of Maine and reception is great, especially from European stations. DXing is addictive! My equipment consists of the RadioShack DX-390 using a longwire, DX-394 shortwave with dipole antenna, GE SuperRadio III, RadioShack PRO-2030, and a Bearcat BC60-XLT, all set up in my den in our new home. My wife’s and my favorite shortwave program is ‘Spectrum’ on WWCR. We were in their studio for their 5th anniversary show.” ■

antennas & things

Simple Antennas And Accessories For Signal Improvement

What On Earth Is EMC And EMI?

Electromagnetic compatibility (EMC) and electromagnetic interference (EMI) are critical to shortwave listeners and scanner receiver operators. The reason is that the receivers that we use are electronic devices, and as such they are expected to perform two functions:

1. To respond properly to desired signals, and
2. They are not supposed to respond to undesired signals.

The problem is not the first of these things. Our receivers usually respond properly to the signals that we try to pick up, and demodulate the signal properly. The problem is in the second of these: They are not supposed to respond at all

to *undesired* signals. The fact is simple: radio receivers often respond to signals that they are not supposed to respond to, often with disastrous results.

Regulatory Issues

The military has long recognized a severe EMI/EMC problem. Their equipment must perform, and perform well, in the presence of fields as strong as 10,000 volts per meter (V/m). The military even has a couple of specifications on EMI/EMC. Their MIL-STD-461 and MIL-STD-462 (in various versions) have traditionally been used for the EMI/EMC requirements, but have recently been replaced by MIL-STD-461E (which

combines '461 and '462).

The European Community issued directive 89/336/EEC to cover the EMI/EMC field. That directive carries criminal penalties, and requires all electronic products to be tested for compliance. The European Community EMI/EMC directive requires every manufacturer or importer of electronic apparatus make a "Declaration of Conformity" for the unit. The "CE" mark must appear on the equipment at least 5 mm high, and be indelibly affixed to the unit (ever wondered what that "CE" mark meant?). Failure to conform to the directive can lead to jail.

The International Electrotechnical Commission and the Organization for International Standards (issuers of the

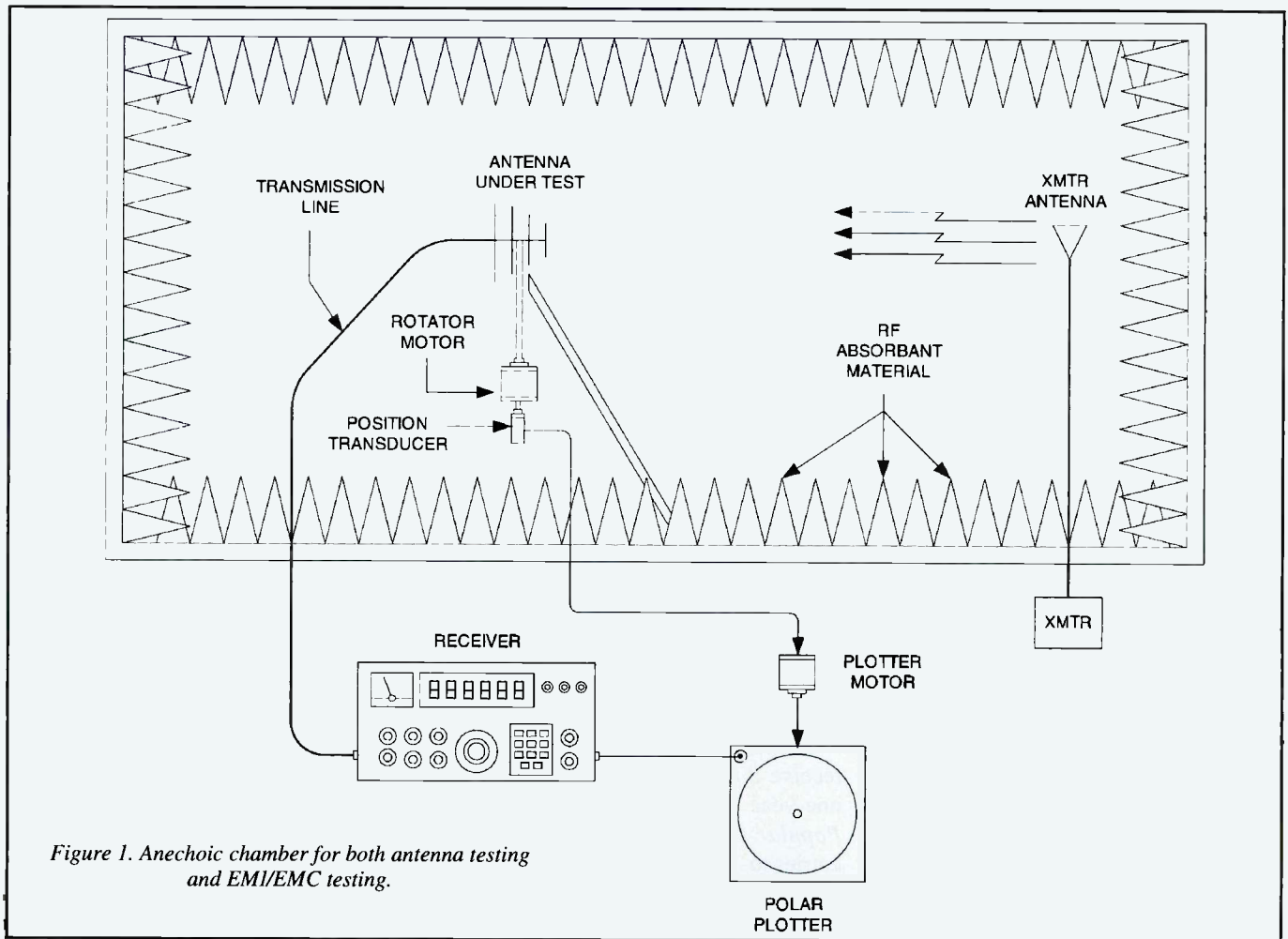

Figure 1. Anechoic chamber for both antenna testing and EMI/EMC testing.

BY JOE CARR, K4IPV <carrjj@aol.com>

Your concept of the word "scanner" is obsolete.

AOR introduces Advanced Technology Receivers™

AR 8200B Wide Range Receiver

The AR 8200B is an all-new receiver, not an update of a previous model.

- 500 KHz~2040 MHz *coverage
- 1,000 memory channels (20 banks)
- Computer control and programming. (requires optional connection cable)
- Download free control software from AOR web site!
- "All Mode" reception includes "super narrow" FM plus wide and narrow AM in addition to USB, LSB, CW and standard AM and FM modes
- True carrier reinsertion in USB and LSB modes. includes 3 KHz SSB filter!
- Detachable MW antenna with negative feedback
- Optional internal slot cards expand the AR 8200B capabilities. Choose from Memory Expansion (up to 4,000 memories), CTCSS Squelch & Search, Tone Eliminator, Voice Inverter and Record Audio (saves up to 20 seconds of audio)
- Tuning steps programmable in multiples of 50 Hz in all modes
- 8.33 KHz airband step is correctly supported
- Noise limiter and attenuator
- Band activity "scope" display with "save trace" capability
- Four-way side panel rocker switch allows one-hand operation
- Large display includes A and B VFO frequencies and signal strength meter
- Battery Save function with Low Battery indicator
- Operates on 12 VDC external power
- 4 AA Ni-Cd batteries supplied, also uses standard AA dry cells
- BNC antenna connector
- Wide choice of accessories

Calling an AOR Advanced Technology Receiver a "scanner" is like referring to a modern fighter aircraft as an "airplane."

AOR has long been at the forefront of receiver technology. The new AR 8200B, and the forthcoming AR 16 Wide Ranger and the limited edition AR 7000B DSP Wide Range Receiver are new concepts that redefine what is possible in wide-band multimode receivers. Discover AOR, the serious choice in Advanced Technology Receivers.™



AOR U.S.F., Inc.
20655 S. Western Ave., Suite 112 • Torrance, CA 90501
310-787-8615 Phone • 310-787-9619 Fax

CIRCLE 15 ON READER SERVICE CARD



These are but a *few* of the features of the new AR 8200B. Visit your dealer or the AOR web site for more information!

*Cellular frequencies blocked in compliance with FCC regulations. Continuous coverage model available for authorized user agencies, documentation required. AOR engages in ongoing efforts to improve its products. As such, design and performance parameters may change without notice or obligation on the part of the manufacturer and/or distributor(s).

famous "ISO-xxxx" series of documents) work closely together. Both are located in the Swiss city of Geneva. The International Special Committee of Radio Interference (CISPR after the French) is the IEC committee that works mostly on EMI/EMC issues. The European Telecommunications Standards Institute (ETSI) and the European Organization for Electrotechnical Standardization (CENELEC) are two organizations that cooperate with the IEC (even though their mandate is solely European) on EMI/EMC matters. In the United States, the American National Standards Institute (ANSI) and the Institute of Electrical and Electronic Engineers (IEEE) are the

responsible parties, with input from the Federal Communications Commission.

The technical vocabulary of EMI/EMC is given in a document called IEC-50. It has definitions given in three languages (English, French, and Russian). It also has a number of terms in Dutch, German, Italian, Polish, Spanish, and Swedish.

IEC-801 defines compliance of electronic units. IEC-801-2 defines testing for electrostatic discharge (ESD), while IEC-801-3 defines equipment for industrial process management and control. Another important IEC document is IEC-1000.

There are a number of standards in EMI/EMC besides 461/462. If a standard begins with a "BS," it is a British standard,

while an "EN" prefix denotes a European standard ("Norme" is the French word for "standard" and is the "N" in "EN"). Some standards are issued as both BS and EN types. For example, BS-800 (on radio interference) is also EN-55014. The "14" in EN-55014 denotes that the standard is derived from CISPR 14.

EN-50081 (Emissions) and EN-50082 (Immunity) are generic standards for equipment that are not covered by other standards. If other standards exist, then they take precedence over EN-50081 and EN-50082.

BS-6527, also known as EN-55022 and CISPR 22, specifies that between 30 and 230 MHz the electrical field 10-meters from digital equipment not be 30 (V/m). That is a lot of interfering signal to be radiated into a receiver! It might not be sufficient for on-channel interference, yet it is the most severe civilian standard in the world.

U.S. Standards

The FCC publishes radio interference standards in the USA, with input from ANSI and IEEE. Part-15 CFR 47 (Code of Federal Regulations) defines the EMI/EMC world of unintentional interference. It recognizes two main classes: **Class-A for business or industrial use, and Class-B for domestic use.** Class-B is stricter than Class-A because radio receivers and television receivers are susceptible to EMI/EMC. Publication *FCC/OET MP-4* describes how to measure the interference emitted by computers and other devices.

Europeans use the same "class-A/B" designation as the USA. In Europe, a Class-B device is (generally speaking) one that operates from a 13-ampere outlet.

Conformance Testing

Conformance testing is done in anechoic chambers (Fig. 1) or on Open Area Test Sites. Figure 2 shows a typical OATS that conforms to EN-55022. If the funds and facilities are available, then an indoor anechoic range (Fig. 1) is preferred. The cones shown in Fig. 1 are 2.5-meters in length at 30-MHz, although they are smaller for VHF/UHF ranges.

The data collected are of far greater usefulness than the data collected outdoors, especially off-the-air. The indoor range is simply a more easily controlled, predictable environment.

The indoor range consists of a room lined with materials that absorb radio waves. Usually in the form of pyramid

When seconds count,
REACT
needs you....



...to summon for help for an injured motorist, an elderly woman trapped in a fire, a trucker stranded in a blizzard, a drowning child!



As a REACT volunteer radio monitor, you may be the only communication life-line for someone in serious trouble. You relay messages from those desperate for help to police, fire, or emergency services.

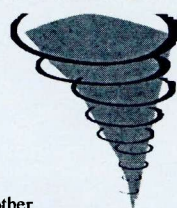

Your REACT team may also use CB, GMRS, Amateur, and other radio services to provide safety communications for events like parades, marathons, and even balloon races. The fellowship with other REACT members at team meetings and annual conventions is an added bonus, as is help with licensing, equipment advice, and radio training.

"The mission of REACT International is to provide public safety communications to individuals, organizations, and government agencies to save lives, prevent injuries, and give assistance wherever and whenever needed. We will strive to accomplish a monitoring network of trained volunteer communicators."

*Add a new, exciting challenge to your life.
Volunteer. Help save lives and property,
JOIN TODAY!*

REACT INTERNATIONAL, INC.

Phone (301) 316-2900

Fax (301) 316-2903

Web: www.reactintl.org

5210 Auth Road, Suite 403

Suitland, MD 20746



• PROUD RECIPIENT OF THE PRESIDENT'S VOLUNTEER ACTION AWARD •

RADIO EMERGENCY ASSOCIATED COMMUNICATIONS TEAM

CIRCLE 71 ON READER SERVICE CARD

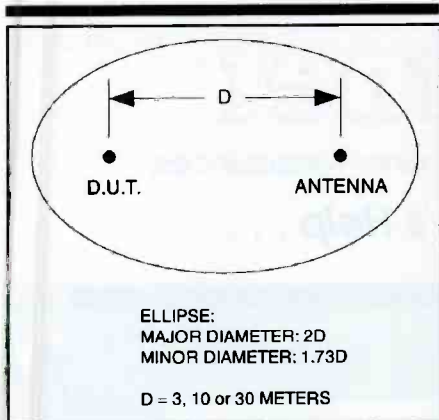

Figure 2. OATS facility.

shaped wedges, various sizes of absorbers are placed over all surfaces of the chamber. The room is inside of a *Faraday cage*. This shielding provides protection against both signals from outside interfering with the test, and reflections of the reference signal from structures outside of the chamber. A point source, such as a small loop at UHF and below, or a horn radiator at microwave frequencies, is positioned at one end of the room.

The same type of range can be used for antenna patterns. The antenna is mounted on a rotatable pedestal. In order to prevent secondary reflections from the pedestal, blocks of absorbent material are often used to block the view of the pedestal from the radiator. Both elevation and azimuth plots can be made by the simple expedient of mounting the antenna in the correct plane for each test.

In antenna measurements, the polar pattern of the antenna is created by using a servomotor or position transducer to rotate a chart recorder that measures the output strength of the receiver. The result is the familiar antenna azimuthal or elevation patterns.

Modern versions of the indoor range use a computer rather than the polar plotter shown in **Figure 1**. The output of the receiver is a voltage indicating signal level, so it can be A/D converted for input to the computer. The position transducer can also provide data to the computer. Once these data are in, a plotting program can draw the polar plot.

One advantage of the computer approach is that a static profile of the chamber can be made by mounting a reference antenna in place of the AUT or DUT. The plot can then be made, and note taken of any reflections or other anomalies that exist in the chamber. These data can then be compared with the data for the AUT or DUT at each angle, with the AUT data adjusted to account for directional differences.

POWERPORT™

WORLDPACK
P/N HMP
\$57.95

Designed to safely carry your ICOM-706 or other mobile radios into the field or carry onto a plane. Separate compartment for optional power supply and antennae. Complete, comfortable and compact.



HOLD-IT RADIO POUCHES
\$19.95

Soft, glove quality leather pouches in a variety of innovative styles, keep your micro-radio safe and easily accessible.



POWERPORT 259
P/N PP259 **\$184.95**

Hand-portable AC/DC power gives you 250W constant AC power and up to 15A of DC power. Rechargeable 9 AH battery keeps your equipment operating anywhere, any time. Shown with optional padded bag.



POWERSAFE
starting at **\$65.95**

You add the automotive or deep cycle battery and we supply everything else you need for extensive, long lasting power backup. Four DC outlets, plus voltage indicator, AC models up to 600 Watts. Automatic charger can recharge your battery through your household wall socket, through your auto cigarette socket, or with our WorldPack solar rechargers. Four different models available.



ORDERS 800: 206-0115
CUTTING EDGE ENTERPRISES
1803 MISSION #PM 546 SANTA CRUZ CA 95060
all other inquires: 831: 429-5384 e-mail cee@cruzio.com

CIRCLE 65 ON READER SERVICE CARD

The advantage of the indoor test facility is that it allows test engineers and technicians to rotate the DUT in any attitude required for the measurements.

The Open Area Test Site (OATS) is used out of doors. An EN-55022 compliant OATS (one of two) is shown in **Figure 2**. The typical OATS is an ellipse with major and minor axes. The Device Under Test (DUT in Fig. 2) and antenna for the test signals are on the metal ellipse. The dimension "D" may be 3-meters, 10-meters, or 30-meters depending on the size of the DUT. The major axis is 2D and the minor axis of the ellipse is 1.73D.

The nature of the OATS ground screen depends on the frequencies for the ellipse. It can be a screen, but the "holes" in the screen should not be a major part of one wavelength at the lowest frequency of operation. The holes in the mesh should be 33-mm, which is one-tenth wavelength at 1 GHz. That is usually not a problem, but the minimum and maximum frequencies of the OATS must be considered.

For straight EMI/EMC testing, the OATS is sufficient because reflections don't bother EMI/EMC tests are much as it does antenna patterns. Nonetheless, care must be taken to locate the OATS

where there are no other structures, overhead wires, or other structures that reflect radio frequency energy used in the test.

The test site should have a RF-friendly structure for the electronics and personnel involved. A glass-reinforced polyester (GRP) facility is often used to avoid RF reflections. A better approach is to put the control electronics and control room below ground.

Screened Rooms

A decent job of EMI/EMC testing can be done inside a screened room, rather than an anechoic chamber. The cost of the anechoic chamber is prohibitive for many users (although one can be rented for a few thousand dollars per day). The screened room is basically a Faraday cage. The size of the screened room is 4 x 5 x 3 meters. In IEC-801-3, however, the size of the screened room will be increased to 6 x 5 x 3 meters.

EMI/EMC is a very important topic for the SWL/monitor community. Next time, I will try to discuss some of the tests and investigations one can undertake to understand the EMI/EMC performance of the radios you use. ■

radio & the internet

Pop'Comm's Cyber Sleuth Checks Out Online Resources

Planning Your Own Website? Here's Help . . .

It's really interesting how our minds tend to fill in the blanks or, in this case, *remove* superfluous information when we're accustomed to seeing things in a specific format. I'll bet I read that column at least three times (as printed in the magazine) and never saw it. I just responded to a *Pop' Comm* reader with an apology for printing what appeared to be an incorrect URL in a previous column. The crux of the problem was a hyphen (-) character in a URL that spanned two lines on the printed page. While technically correct in terms of publishing, it was quite misleading, particularly when I've emphasized URLs printed here need to be typed EXACTLY as printed. (The Sleuth is blushing). While we'll try to prevent that from happening, I'm sure it will crop up again — if not here, somewhere else. So, here's a tip: Whenever you see a URL that spans two lines and the first line ends with a hyphen, ignore the critter when typing the URL. In most cases, the hyphen will not be part of the URL. Then, if you should get a "URL not found" error, just put the hyphen in and try again.

Your Name In Lights

Harold and I were chatting a while back about the possibility of a series on how to build your own web site. On the surface, it seemed like a super idea, but given the complexity of the subject, it just wasn't feasible for a monthly column. However, there's another way to get YOUR (really nice looking) Web page(s) up and running. It's quick. It's easy, requires NO programming, and best of all it's FREE! It's a Web site community provided by XOOM.COM. Standing (in my opinion) heads and shoulders above the rest, they provide the best overall service with extras (including free E-mail, artwork, templates, etc.) that will make your site easy to build and shine when finished. If you have tons of material you'd like to include, don't worry. XOOM.COM provides you with UNLIMITED disk space. Others require you to pay for storage above a few megabytes. The catch? A small, unobtru-

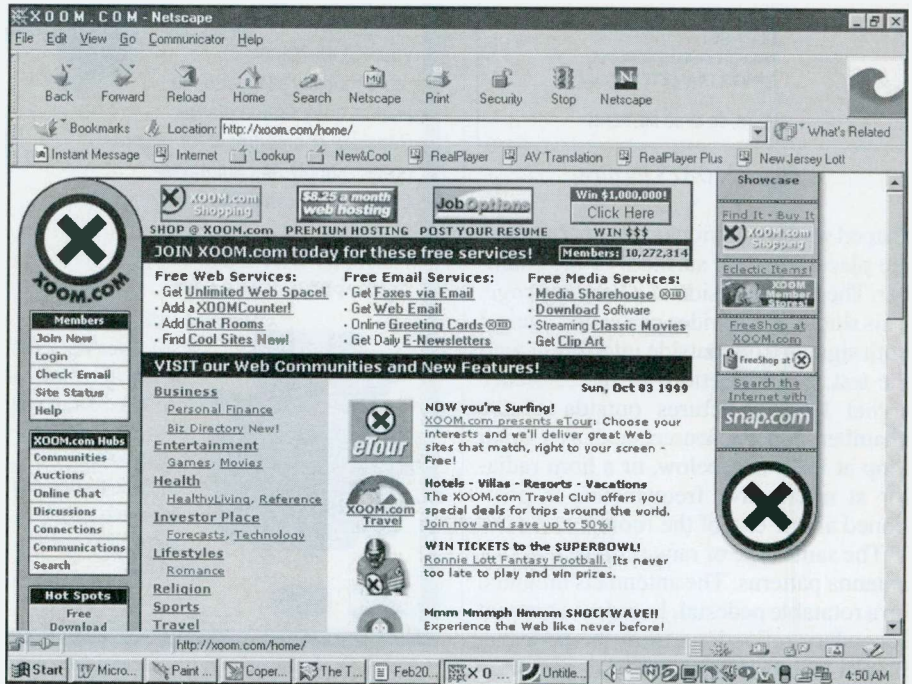

It's easy, free, and requires no programming.

sive, advertising banner will be displayed at the top of each of your pages. Additionally, you'll probably receive an E-mail every 2 or 3 days promoting a "special offer" for Xoom members. I'd call Xoom's way of handling the necessary advertising a class act when compared with the way some other free services force a giant ad to pop up on every displayed page. If you'd like your own web site up and running in record time and for FREE, XOOM.COM is the place to go. They're at <<http://www.xoom.com/>>.

Ham Radio Super Site

Featuring over 700 amateur radio topics from Abbreviations to Zones, Rod Dinkins' "AC6V Amateur Radio and DX Reference Guide" is the kind of site that

AC6V's

Amateur Radio and DX Reference Guide



could put the old Sleuth out of business. Regardless of your interest in radio, Rod most likely has a reference (no, make that several references) to it. Not only are those references easily found, they're extremely well-organized and defined. This site is so easy to navigate; I had to pinch myself to be sure I wasn't dreaming. Many sites attempt to impress visitors with lots of window dressing and tons of URL links with little concern about quality, ease of navigation, or what's at the end of those URLs. Not so here. Rod has done it the hard way, putting YOU first in terms of overall design. You'll find fast page loads with the quality references and

BY ERIC FORCE <eric@dobe.com>

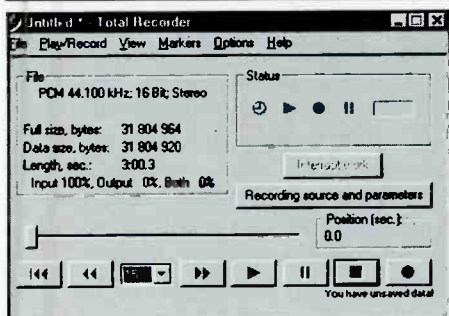

If you can hear it through your PC's sound system, Total Recorder can record it for you.

information you need just a few clicks away. His main page index is titled "Gateway to Ham Radio." I'd alter that a bit to read "Gateway to Radio." And, complimenting an already superior infrastructure, you'll find a fast site search engine to speed things up more. Folks, in a word, this site is AWESOME and one that you MUST VISIT and BOOKMARK at <<http://www.ac6v.com/index.html>>.

Online Price Comparisons

The Internet offers an incredibly easy way to compare and shop. "E-commerce" (a.k.a. Sales via the Internet) is the wave

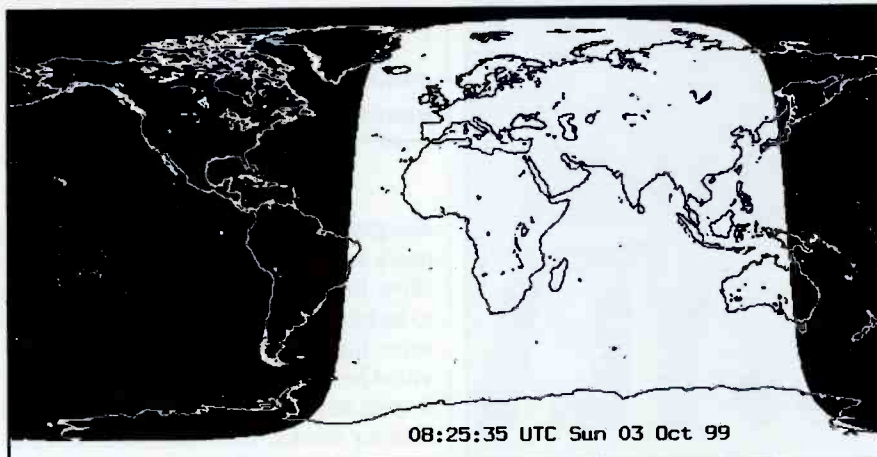

An online resource for DXers.

of the future and is growing by leaps and bounds. With more and more sites offering secure encrypted transactions, concerns over security are diminishing as well. If you can think of it, you can probably find and buy it online. Whenever I'm looking for consumer goods, I first visit PriceSCAN.com to find the best price. I recently upgraded my PC's sound system and paid about \$75 less (for the exact same components) compared to another online

vendor. It really DOES pay to shop around and PriceSCAN.com makes it easy! Since PriceSCAN.com accepts no money from vendors in exchange for listing their products and prices, you can be pretty confident that the search results are unbiased. I've been quite pleased with their free service — I think you will be too! Check 'em out at <<http://www.pricescan.com/>>.

Remember, when comparing prices be SURE to include shipping and handling

CB'ers.

What do YOU need?

A CHOICE!

- Six Antenna lengths up to 7 feet.
- Compact cellular-look-a-likes.
- No-Ground-Plane RV antennas
- The bare-hands tunable tip
- Super-flexible off-road whips



FREE CATALOG

tel: 602-273-7151
 fax: 602-273-1836
 e-mail: support@firestik.com
<http://www.firestik.com>

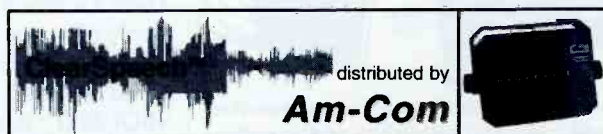

ClearSpeech™ Speaker

Digital Noise-Canceling Speaker for Two-Way Communications

This easy-to-use DSP speaker activates automatically and filters 95% background noise, static, and other interference.



\$129.95*

*plus \$8.50 S&H
 (regular price \$149)

- Improves clarity & intelligibility
- Continuous, adaptive removal of background noise
- Listen with less fatigue & greater concentration
- Improves signal to noise ratio
- New: increased audio output, and speaker jack added.

It Works!

Website: www.amateurcommunications.com
 (Secure Ordering On-Line)



Email: amcom@digisys.net
 Phone orders: 1-888-803-5823



Mail Orders To:

Am-Com, P.O. Box 356, Lakeside, Montana 59922
 Product Information Only: 1-406-844-3252

YOU
AIN'T
HEARD
NOTHIN'
...YET

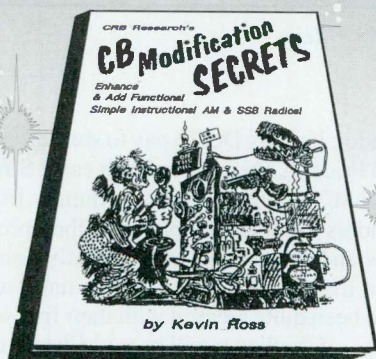

Since 1967, CRB Research has been the world's leading publisher and supplier of unique hobby and professional books and information including:

- Scanner Frequency Guides
- Shortwave Freq. Guides
- Military/Federal Comm.
- Broadcast Station Registries
- Undercover Communications
- Survival Communications
- Covert Operations
- Electronic Espionage
- Surveillance
- Monitoring
- Cryptography & Code
- Bugging
- Wiretapping
- Communications Antennas
- CB Radio
- Computer Technology!
- & Other Related Topics!

**BIG
FREE
CATALOG**

New titles are constantly being added to our exciting catalog. If it's interesting and unusual, we've got it. You'll see.

CRB Research

P.O. Box 56, Commack, NY 11725
Phone: (516) 543-9169
FAX: (516) 543-7486
e-mail: sales@crbbooks.com
www.crbbooks.com

"... is the kind of site that could put the old Sleuth out of business."

charges in the equation. I've noticed that more and more firms are beginning to show lower prices for goods but appear to be increasing their S&H charges at the same time. If S&H charges are not provided *before* you are asked for your credit card number, I'd suggest considering another vendor. Also, for maximum protection, be sure the online vendor you select uses a SECURE server for credit card transactions.

Lightning Fast Page Loads

It would seem some web designers today think we all have a direct T1 (or better) connection to the 'net. Truth is, many of us are limping along with a 28.8K dial-up connections. Yes, you may have a 56K modem and the latest PC technology, but I can almost guarantee your actual data throughput falls short of 56K. Wouldn't it be nice if you didn't have to wait for two forevers for those favorite web pages (with tons of graphics) to load? Well, you don't! There's a way to speed up things considerably after you've once visited a site — it's termed a "Web Accelerator" and it's called NetSonic. It really works (on SUBSEQUENT visits to a page) and the basic version is FREE! Additional information can be found at their site and download page. One caveat: the free version requires manual reloading of web pages to update NetSonic's cache database. This means if you're not on your toes, and miss NetSonic's subtle warning about a change in the page contents since your last visit, the page that just popped up "instantly" might NOT be the most current. TIP: If in doubt, hold your SHIFT key down and click your browser's page reload button. Holding the SHIFT key down FORCES a NEW page load from the SERVER. Without the SHIFT key, you might be reloading an old copy from your disk cache. Netsonic is, as you might imagine, at <http://www.netsonic.com/>.

Total Recorder

Total Recorder, by High Criteria, Inc., is a nifty little PC application I stumbled on recently and was so impressed, I registered it after about fifteen minutes of

use. Total Recorder can record any sound being played by other audio players, either from a file or from the Internet. It can also record conventional audio from CDs, a microphone, and other lines on a sound card. Put another way, if you can hear it through your PC's sound system, Total Recorder can record it for you. I've found it particularly useful as a recorder when using my RealPlayer G2. Those of you with PC-based receivers might also find this program quite attractive. The only "negative" is that it records in WAV format meaning tons of disk space can be gobbled up quite rapidly. For example, recording a three-minute passage at 11KHz, 8 bit, mono (Phone quality) would use about 2MB of disk space. If you opted for 44KHz, 16 bit, stereo (CD Quality) you'd be looking at about 32MB of disk space. Hey! Maybe that's not so bad. What a super excuse for buying that new 20GB+ drive you've been dreaming about. Be sure to use PriceSCAN.com to find the best price.

The evaluation version is fully functional except that your recordings are limited to 40 seconds each. For unlimited recording, you'll need to register the product. Registration fees are \$11.95 U.S. or \$17.95 Canadian. Download your free evaluation copy at <http://www.highcriteria.com/>.

Time, Date, And Suncllock Information

Dr. Alex A. Sergejew, Principal Lecturer at Swinburne University of Technology, Melbourne, Australia, has compiled one of the most comprehensive list of links to TIME & DATE resources I've run across. If you're seeking worldwide time or date information, you'll find a pointer to it at <http://ecco.bsee.swin.edu.au/chronos/chronos.html>.

For those of you utilizing Skywave signal propagation, Dr. Sergejew's "Sun-Clock — Where is the Sun Shining Right Now?" application is a slick, don't miss, resource at <http://ecco.bsee.swin.edu.au/chronos/suncllock/suncllock.html>.

Here we are again, out of space. Thanks for joining me on this month's journey into cyberspace. Be sure to visit the *Pop' Comm* Website at <http://www.popular-communications.com/> for the latest and greatest, and don't forget to E-mail me those suggestions for resources you think should be shown here. Also, please note my new E-mail address: eric@dobe.com. Until next time, 73. ■

Books, Videos, Calendars, Cards!

Visit Our Web Site
www.cq-amateur-radio.com

33 Simple Weekend Projects

by Dave Ingram, K4TWJ

Do-it-yourself electronics projects from the most basic to the fairly sophisticated. You'll find: station accessories for VHF FMing, working OSCAR satellites, fun on HF, trying CW, building simple antennas, even a complete working HF station you can build for \$100. Also includes practical tips and techniques on how to create your own electronic projects.



Order No. 33PROJ.... **\$15.95**

The NEW Shortwave Propagation Handbook

by W3ASK, N4XX & K6GKU

A comprehensive source of HF propagation principles, sunspots, ionospheric predictions, with photography, charts and tables galore!

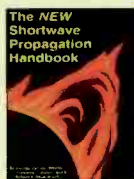

Order No. SWP..... **\$19.95**

Amateur Radio Equipment Buyer's Guide

This 144-page book is your single source for detailed information on practically every piece of Amateur Radio equipment and accessory item currently offered for sale in the USA complete with specs and prices. Also includes the most comprehensive directory of Ham product manufacturers and dealers in the USA.



Order No. EBG..... **\$15.95**

Building and Using Baluns and Ununs

by Jerry Sevick, W2FMI

This volume is the source for the latest information and designs on transmission line transformer theory. Discover new applications for dipoles, yagis, log periodics, beverages, antenna tuners, and countless other examples.



Order No. BALUN... **\$19.95**

The Vertical Antenna Handbook

by Paul Lee, N6PL

Learn basic theory and practice of the vertical antenna. Discover easy-to-build construction projects.



Order No. VAH..... **\$9.95**

McCoy on Antennas

by Lew McCoy, W1ICP

Unlike many technical publications, Lew presents his invaluable antenna information in a casual, non-intimidating way for anyone!

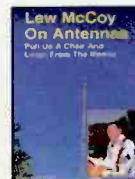

Order No. MCCOY..... **\$15.95**

The Quad Antenna

by Bob Haviland, W4MB

Second Printing

An authoritative source on the design, construction, characteristics and applications of quad antennas.

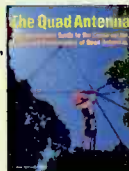

Order No. QUAD..... **\$15.95**

Keys, Keys, Keys

by Dave Ingram, K4TWJ

You'll enjoy nostalgia with this visual celebration of amateur radio's favorite accessory. This book is full of pictures and historical insight.



Order No. KEYS **\$9.95**

W6SAI HF Antenna Handbook

by Bill Orr, W6SAI

Inexpensive, practical antenna projects that work! Guides you through the building of wire, loop, Yagi and vertical antennas.



Order No. HFANT..... **\$19.95**

Getting Started Videos ~ "How-To," Tips, Techniques & More!

- Ham Radio Horizons: The Video .. Order No. VHOR
- Getting Started in VHF .. Order No. VVHF
- Getting Started in Ham Radio .. Order No. VHR
- Getting Started in DXing .. Order No. VDX
- Getting Started in Packet Radio .. Order No. VPAC
- Getting Started in Amateur Satellites .. Order No. VSAT
- Getting Started in Contesting .. Order No. VCON



Only \$19.95 each
Buy more and save!
Buy 2 or 3 for \$17.95; Buy 4 to 6 for \$15.95
Buy all 7 for your Club for only \$99.95

Fax us at 516-681-2926
Call us toll free at 1-800-853-9797

1999/2000 Calendars



\$9.95

Fifteen month calendars
January 2000 through
March 2001

Please specify
Amateur Radio or
Classic Radio Calendar



CQ Award Pins

If you've earned any of CQ's Awards, you can also display the corresponding CQ Award pin. Available for WAZ, 5 Band WAZ, 160 Meter WAZ, CQ DX, CQ DX Honor Roll, WPX, WPX Honor Roll, and USA-CA awards. **ONLY \$5.00 EACH.**

Playing Cards

Top quality, plastic coated playing cards. **ONLY \$9.95 per deck**



FREE SHIPPING
on orders over \$50*

Name _____ Callsign _____
Street Address _____
City _____ State _____ Zip _____

Qty	Item #	Description	Price	Total Price
U.S. and possessions - add \$4 shipping/handling. *FREE S/H on orders \$50 and over. Foreign - shipping/handling charges are calculated by order weight & destination. *A \$4 credit will be applied for Foreign orders over \$50.			Shipping/Handling	
			Total	

Method of payment Check Money Order Visa MasterCard Discover American Express

Credit Card No. _____ Expiration date _____



CQ Communications, Inc., 25 Newbridge Rd., Hicksville, NY 11801/516-681-2922; Fax 516-681-2926

the radio connection

A Look Behind The Dials

Restoring The American Bosch Tombstone Radio

I'm having a hard time getting into the spirit of the New Year, perhaps because I'm writing this column in the middle of October as the New England seasons change for the worse! The days are getting short; it's only 7 p.m. and yet it is already pitch black outside. No ham-fests or radio shows for several more months; and many small radio-related outside jobs left undone until next Spring. I still haven't moved the antenna farm's numerous coaxial feeds into the new "Radio Connection's" World Headquarters, thanks to a full Summer's worth of procrastination induced by a season of unusually warm and humid weather.

We Have Another Winner!

Entries for the Boy's First Receiver construction project have been arriving, in a slow, but steady fashion. John Haught is our January contest winner, and John will receive a one-year gift subscription or renewal to *Popular Communications* for his winning entry. Here is John's letter:

"Hi Peter. I have an ardent interest in one and two tube regenerative receivers of the 1930s. I constructed your radio, The Boy's First Receiver, from the plans shown in the August 1999 issue of *Popular Communications* magazine. I must say, I fired it up before the last solder joint was cold, and I picked up DX with the #2 shortwave coil and a short indoor antenna within a few short minutes!

The only changes I made from your instructions were installing a 0-75pF variable antenna capacitor in place of the 60pF trimmer, and using a two-gang 365pF capacitor (using only one section) as it is something I have surplus in my parts inventory. The tube I used is a type 30.

I am a purist (age 72) when it comes to building 1930s receivers and CW transmitters; therefore I don't deviate from the schematics and parts from that time period. I know many improvements can be made with present day technology, and that new or different parts can be substituted; but I am interested in how the radios looked, operated, and sounded



John Haught's regenerative receiver.

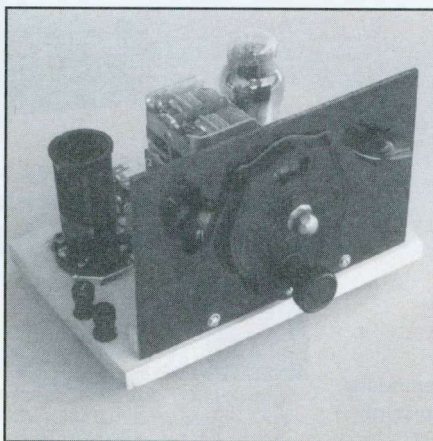

Front view of the receiver.

when the old Brandes or Cannon-Ball Dixie headsets were plugged in and the antenna connected!

I am looking forward to the construction of the one-tube audio amplifier, and other future 'oldie' projects that you have planned. If everyone followed your instructions and parts layout, they too are enjoying their Boy's First Radio!"

John, thank you for your letter and the photos. Your little receiver looks very nice, and I am sure it plays as well as it

looks. The rear view photo shows the workmanship that went into the little radio. Some of the wiring is hidden beneath the breadboard in the fashion of many sets of that era. A phenolic barrier strip for mounting the Fahnestock clips also lends a nice finishing touch to the set.

A Reader And Collector Writes In

Reader Bill Morris submitted the following letter and photo last year, and I must apologize to Bill for the long delay in using his material. Bill writes: "I always wanted an old radio to mess with partly because of an old Philco TV we had when I was 10 years old. The set's innards fascinated me. I had never seen tubes before, and it was amazing that anyone could repair a TV just by replacing those little glass bottles. I was so infatuated, that I built little TV sets out of Lego's and played repairman.

When Father's Day rolled around in 1985, I wanted to get my dad something different than the usual shirt-and-tie gifts. I decided an old radio might be a step in the right direction. I went to the library and picked up a book I'd never seen

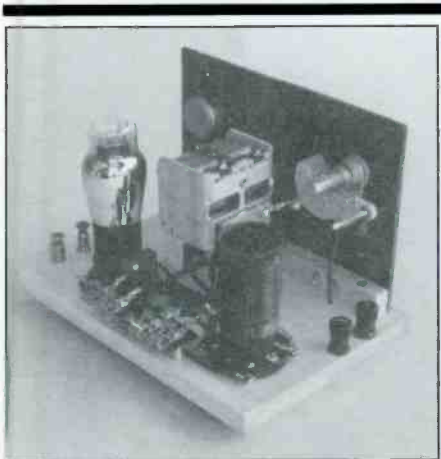

Rear view of the receiver. John has produced a very symmetrical layout, with all of the components mounted and wired together in a very professional manner.



Here is Bill, smiling and feeling quite pleased with his Zenith 5S127 tombstone acquisition.

before — *Flick of the Switch* by Morgan McMahon. It was just what I needed. Two weeks later at my brother's wedding, a gentleman offered me a Zenith 5S127 tombstone radio. I looked the radio up in McMahon's book, saw what it looked like, and took the bait.

It took another two months to repair it (with a lot of help from old-time repairmen), but the thrill arrived when I brought it home, turned it on, and heard *Fibber McGee and Molly* emanate from the speaker. An old radio program playing on an old radio. I was hooked!

Shortly after that, I wanted to get into shortwave, and discovered the Zenith Transoceanic. I purchased two at a ham-

R30 WORLD BAND SHORTWAVE RECEIVER



FEATURES

- Full Coverage
- Adapter/Battery Pack
- LW/MW/SW
- +15dBm Intercept
- LCD Display
- High Dynamic Range
- AM/LSB/USB
- Optional Collins Filter
- 100 Memories
- Super SSB

The PALSTAR R30 sets the standard for compact high-performance receivers. With its 8" x 7" x 2.5" chassis the R30 has 6 switchable input filters, a two-loop RF derived AGC system and a 3 Watt amp for superb audio. Optional Collins torsional mode filters are available for those shortwave listeners that want the best. Designed and built in the USA. Visit our web page at www.palstarinc.com for more details.



PALSTAR INC.
PIQUA, OH
U.S.A.

9676 N. Looney Road, P.O. Box 1136, Piqua, Ohio 45356

Tel: (937)-773-6255 Fax: (937)-773-8003

Email: Palstar@erinet.com Visit our website at <http://www.palstarinc.com>

CIRCLE 69 ON READER SERVICE CARD



"ATOMIC TIME"

Time Pieces Synchronized to the US Atomic Clock
Accurate to ten billionth of a Second!



You can now have the world's most accurate time 24 hours a day. These smart clocks tune into the radio signal emitted by the US Atomic Clock in Colorado, which deviates less than 1 second over a million year period. They synchronize themselves automatically to the precise time and adjust for daylight savings. These precision ZEIT timepieces are engineered in Germany and are easy to use using the latest in radio-controlled technology. Just set the time zone and the built-in microchip does the rest.

"ZEIT Atomic Time" Precise, Reliable, Convenient

ZEIT Atomic Dual Alarm & ZEIT Atomic PC

Sleek European design with large 2 line LCD display with exact time in hours, minutes, seconds, month and date, or any two US and world times. At 8oz. ideal for travel; incl. dual alarm with nighttime illumination, time zones and lithium battery backup. Super sensitive built-in receiver. 2AA. incl. Black or Silver arch design at 5"x4"x2 1/2" **Sale! \$69.95.** Buy any two Clocks & get 20% off 2nd.

ZEIT PC with serial cable and software for WIN. Also shows UTC Time in 24 hrs mode. **Sale! \$99.95**

ZEIT Atomic Wall Clock

with regular or Roman numerals. For home or office. One AA Battery. Large 12" **Only \$79.95 (\$99.95 in wood)**



ZEIT Atomic Watches are the world's most accurate watches. Shock-resistant polymer case with built-in receiver, hardened mineral lens, water resistant. Black or white dial & leather band. **Only \$149.95**
NEW ZEIT Digital Atomic Sportswatch with UTC etc. **Just \$99.95**



Call for full line of atomic clocks & watches

THE FUTURE IN TIME KEEPING

Credit Card Orders call toll free 800-339-5901

send checks / money orders for the total amount incl. S & H \$7.00 to: **ATOMIC TIME, INC.**

1010 Jorie Blvd., Suite #332, Oak Brook, IL 60523- Please mention promotional Code 8484 when ordering
Fax: 630.575.0220 <http://www.atomictime.com>

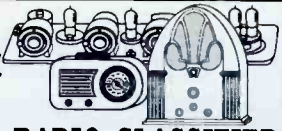

CIRCLE 60 ON READER SERVICE CARD

FREE SAMPLE COPY!



ANTIQUE RADIO CLASSIFIED
Antique Radio's Largest-Circulation Monthly Magazine

Articles - Classifieds - Ads for Parts & Services
 Also: Early TV, Ham Equip., Books, Telegraph, 40's & 50's Radios & more...
 Free 20-word ad each month. Don't miss out!

 1-Year: \$39.49 (\$57.95 by 1st Class) 
 6-Month Trial - \$19.95. Foreign - Write.
 A.R.C., P.O. Box 802-T14, Carlisle, MA 01741
 Phone: (978) 371-0512; Fax: (978) 371-7129
 Web: www.antiqueradio.com

WOW!

Have you read Scanning USA, the ONLY scanning magazine? Get more out of your scanner with exclusive columns such as:

SCANNING USA



Aviation
 Trunking
 Federal/Military
 Internet And Radio
 Railroad
 Product Reviews
 Beginners Corner
 And Much More!
 Subscribe today!

 Call 1-800-651-0922 
 Sample \$3.00 8 Issues \$16.95
 16 Issues \$33.95 26 Issues \$49.95
 Scanning USA: 2054 Hawthorne Joliet IL 60435
[Http://home.att.net/~scanningusa](http://home.att.net/~scanningusa)
Scanusa@compuserve.com FAX 815-722-0717

CIRCLE 67 ON READER SERVICE CARD

WORLD FAMOUS!!
"TINY-TENNA"

Indoor Amplified Shortwave Antenna
 Great for apartment/condo, traveling, camping!
 (requires 9V battery or AC adapter-not included)
 credit card orders welcome at:
1-517-563-2613 
 DWM Communications
 P.O. Box 87-PC, Hanover, MI 49241

Grundig Satellit 800



The Perfect High Performance Receiver for Beginners and Seasoned SWL's Alike!

Frequency Coverage:
 100kHz - 30 MHz (AM/USB/LSB)
 118-137 MHz (AM Aircraft)
 87-108 MHz (FM Broadcast)

Durham Radio Sales & Service, Inc.
 1380 Hopkins Street, Unit 10, Whitby, Ont. L1N 2C3
 Ph: (905) 665-5466 Fax: (905) 665-5460
 Web: <http://www.shortwavestore.com>
 e-mail: receivers@shortwavestore.com

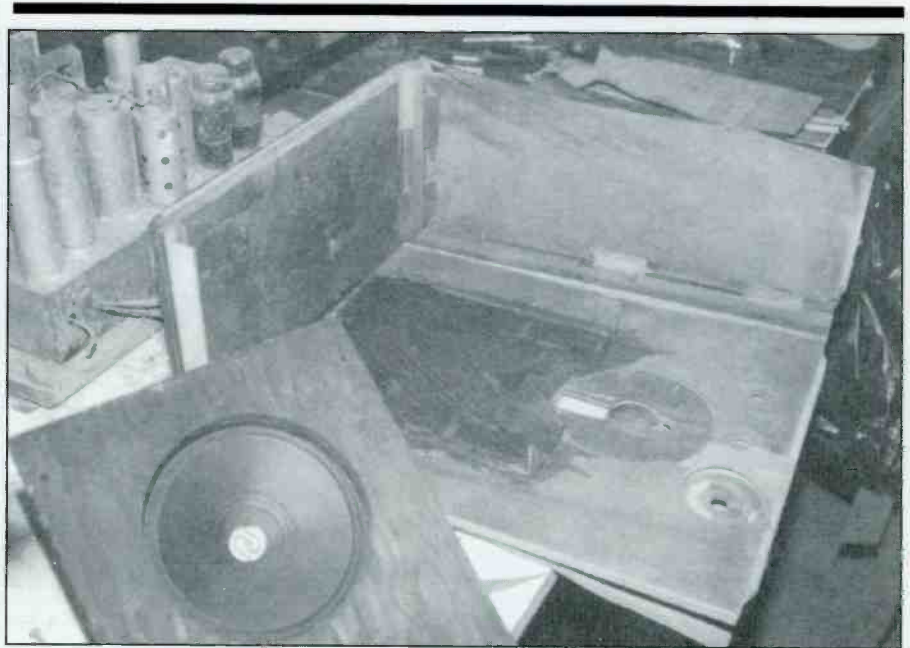

Oddly, the first step in restoration involved disassembling the set into the smallest possible sections.

fest that year: a transistorized Royal 1000 and an earlier 8G005YT model. Thirteen years have since past, and now I focus my collection on personal portable radios. My collection now includes six Transoceanics, early U.S.-manufactured transistor radios, early 45 rpm record players, a few table sets, a Scott 800B, and a smattering of old telephones (my most recent diversion). I used to say 'Boy, I wish I owned these sets.' Now it's 'What am I going to do with all of these sets?'

All-in-all it has been a satisfying hobby, especially now that I am confident in

restoring the sets I own. Most of the experience comes from building a regenerative set and an AC/DC set from scratch. The experience gave me the confidence and basis to dive in and do the job right with a minimum of tears or profanity! Thanks for the column. You're doing a great service for the collecting community."

Tales Of American Bosch

Last month, I started relating my experiences with a rather sad tag-sale find: a decrepit American Bosch model 430T

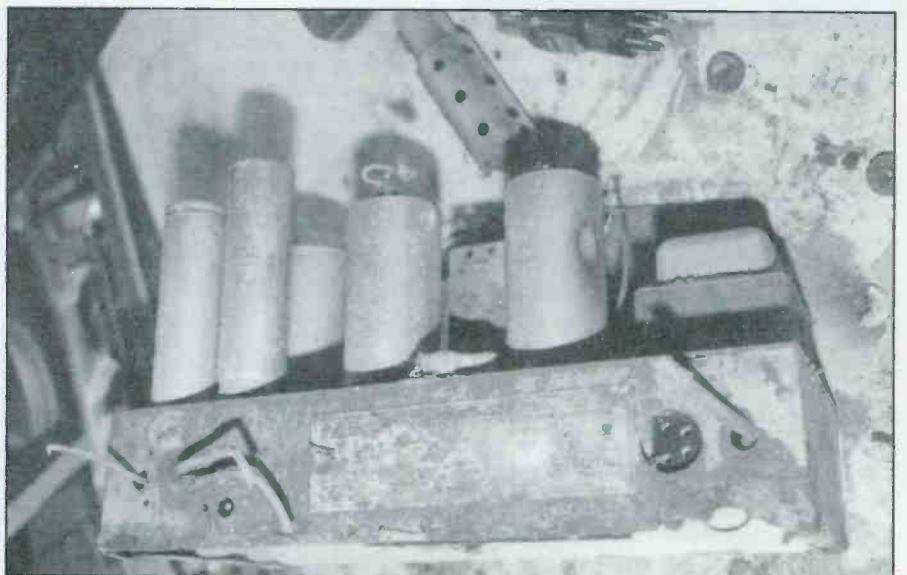

The chassis is a total mess. Notice the severe rust damage and copious amounts of sand covering the immediate work area.

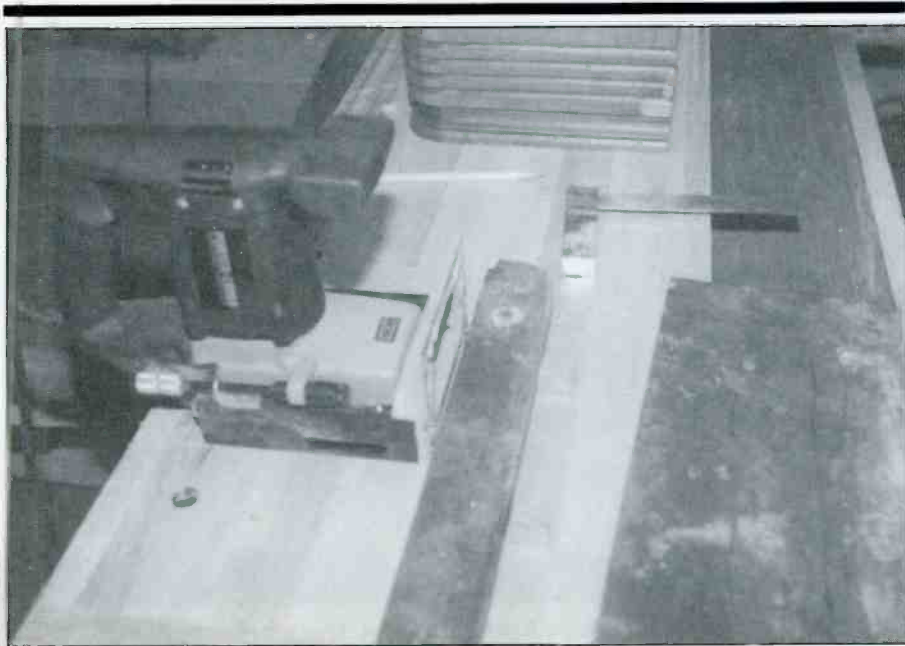

A mundane task, but repairing the baseboard is an important first step because it provides a foundation for the cabinet and chassis mounting. The split is repaired using a biscuit joiner.

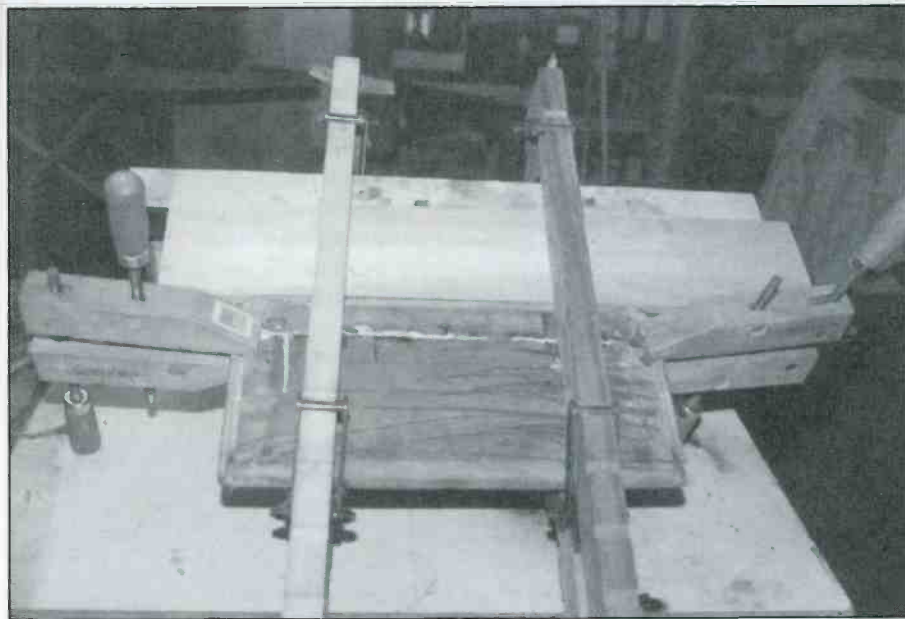

Once the biscuits are in place and everything glued, the two baseboard sections are held parallel to each other with firm edge pressure using special wood clamps.

tombstone. The radio represented one of the worst examples of how to store a radio for 40 years: on a damp cellar floor.

Unfortunately, woodworking is sometimes just as important as the electronic restoration of a vintage set. Perhaps more so. The electronic restoration is often hidden below chassis, and out of sight, while the cabinet is there for all to see. Poor workmanship, improper techniques or finishes is easily spotted even by the

novice collector. Even if woodworking is not your forte, I hope you find the processes involved in saving this set to be at least interesting to read and learn about.

Oddly, the first step in restoring the radio was its complete disassembly, almost to the point of what would appear to be wanton destruction. This involved removing the chassis and speaker from what was left of the cabinet. Take a good look at the chassis. It is severely rusted,

STOP! LOOK & Listen to This!

Alinco DJ-X10T – We've reinvented the multichannel receiver!

- 1200 memories plus two VFOs
- 100 KHz – 2 GHz coverage*
- WFM, NFM, AM, USB, LSB and CW modes
- Alphanumeric channel designations – up to 3 lines
- Multi-function Channel Scope™ display
- Internal "help" function
- PC programmable
- Beginner and Expert operating modes
- Automatic Memory Write Feature
- Auto timer on/off, internal clock
- Backlit display and keys



The Alinco DJ-S46 FRS radio will have YOU talking!

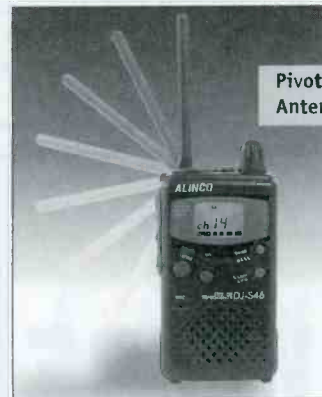

- NO License Needed
- Up to 2 mile range**
- 14 Channels
- FM Transmit/Receive
- NiCd, Alkaline or External Power
- Long Battery Life
- Self Storing Antenna
- Compact Size
- Simple Operation
- Lighted Display
- Accessory Ports
- Compatible with other FRS radios

Visit our web site!

Simple • Clean • Dependable

ALINCO
RADIO'S VALUE LEADER™
 Dealer Inquiries Welcome

U.S.A. Alinco Branch: 438 Amapola Ave.
 Suite 130 • Torrance, CA 90501

Phone: (310) 618-8616 • Fax: (310) 618-8758
 Internet: <http://www.alinco.com>

*Cellular blocked. **Effective operating range varies due to terrain, channel use, batteries and other conditions

to the point where areas along the chassis bottom have completely rusted away. The entire chassis was also encrusted with a layer of sand deposited from nearby decaying cement walls.

The cabinet was carefully — and entirely — disassembled. Great care was taken to save every scrap of wood and to note where it was used in the cabinet construction. This is a vital step when it comes time to replicate missing or damaged pieces. Veneers were removed by soaking the veneered pieces in pans of warm water until the glue dissolved. Once free, the veneer sections were further washed to remove all traces of glue, and then dried between pieces of wax paper and held flat under pressure.

One of the more mundane tasks was the restoration of the baseboard; which is the foundation for the remainder of the radio cabinet and the base to which the radio chassis mounts. The pine baseboard had several problems. It was riddled with worm holes, was punky, and had split into two pieces. I wasn't able to determine if the base was originally made of two sections edge glued together, or if it was one piece that had broken into two sections.

The split was repaired using my Porter

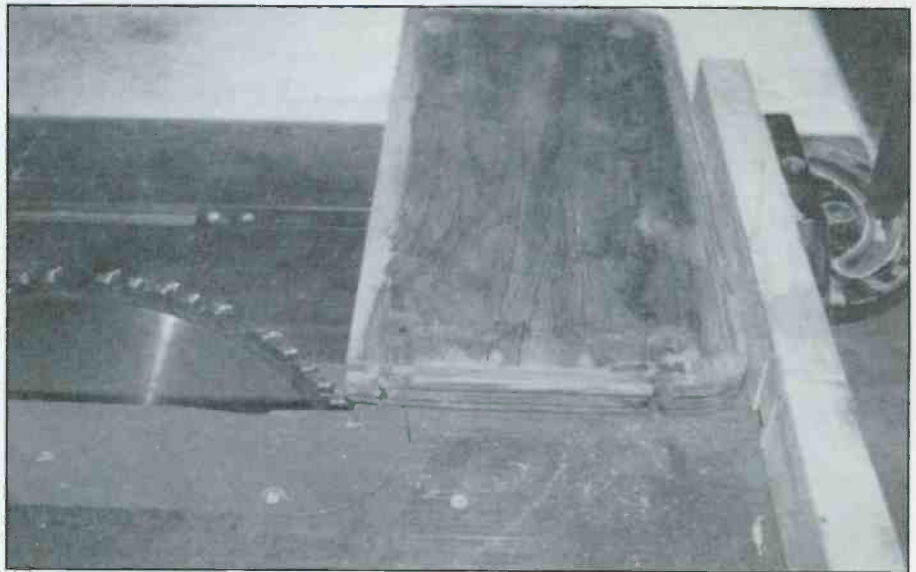

Unfortunately, a few edges around the baseboard show signs of severe water damage and cannot be repaired. The damaged areas are carefully cut away using a table saw.

Cable biscuit joiner. This device is for edge joining two pieces of board, using oval sections of compressed birch wood as splices. Once the machine notches the board edges, the biscuits are inserted into the machined holes, and the glue causes them to expand and form an extremely strong edge joint. Punk areas were dug out with a knife and patched using wood filler. Once the filler dried, the patched areas were sanded flat. There are several products on the market for strengthening punk (rotted) wood damage. The least expensive are acrylic-based, and can be found at most hardware stores. The idea behind these products is to strengthen the wood

so it can be sanded, drilled, or cut without damage. Once the base was repaired and glued, it was necessary to saw away the edges of board that had severely rotted. It was impossible to save these areas, so they were replaced with maple strips (this area was painted with black lacquer, the difference in woods would not show when the set was finished).

Well, with all of the photos this month, I'm running out of space. Thanks for stopping by, and see you again next month. Besides continuing with the Bosch restoration, I haven't decided what else will be in that issue, so you can be as surprised as I am when the magazine arrives! ■

www.popular-communications.com

**WE'RE
ON
THE
WEB!**



Maple strips replaced the damaged sections that were previously removed. Soft punky areas of the pine baseboard have been dug out with a sharp penknife, filled with wood filler, and sanded smooth.

radio resources

Interesting Thoughts And Ideas For Enjoying The Hobby

Looking For An Inexpensive, Used 3-30 MHz SSB Rig?

“If all the high seas radiotelephone services are going off the air, why should I keep this expensive high-frequency, single-sideband transceiver onboard?” comments Marvin Rohrs, an East Coast sailor preparing to head off over the Atlantic. “The only shore station with major-sized antennas that could reach out across the ocean was AT&T stations WOO and WOM, and they are soon to go off the air,” explains Rohrs as he was preparing to yank out the marine SSB and replace it with a relatively expensive satellite communications system.

High seas boaters and sailors are most affected by the abandonment of high-frequency, shore-station services because small satellite terminals that work off of geostationary spot beams won't go beyond 200 miles out from shore.

“When you're halfway across the Atlantic, who ya gonna call in an emergency?” Rohrs added as he began to yank out the high-voltage wire going to his insulated longwire backstay.

But don't yank out the equipment just yet because there are some changes going on regarding high-frequency single sideband that could give that marine SSB some added value far out at sea. All you need to know is what frequencies to reprogram in over the old AT&T channel line-up.



This S.G.C. marine SSB rig is already factory pre-programmed for ham radio use.

For decades, AT&T handled high-frequency, single-sideband radio calls from ships at sea all over the world from San Francisco's KMI station, New Jersey's WOO station, and the powerful Fort Lauderdale WOM station. An elaborate array of rhombics, log periodic antennas, phased verticals, and specific frequency beams gave AT&T one of the loudest signals over high frequency. If you had an

emergency, calling on any one of the AT&T high-frequency SSB channels would quickly get a response.

AT&T operators, like John Morgan at WOO, and Earl Weiler at WOM, were fast to react to any mayday call coming in on any one of their working channels. Earl recounts that an incoming mayday can almost instantly be transferred over to a United States Coast Guard Rescue &



This Kenwood marine commercial boat SSB doubles as a great ham rig after a simple mod.



This Furuno high frequency marine SSB radio has continuous transmit and receive from 2 to 29.99 MHz.

BY GORDON WEST, WB6NOA



From ICOM is this powerful 150-watt marine SSB rig costing \$1,400 new. It was sold for \$300 at a marine swap meet. A computer upload turns it into a ham set.



This little SGC sideband radio is already set for unlimited ham radio frequency coverage from 2 to 29 MHz!

Coordination Center (RCC) for a telephone patch; and once the immediate danger was over, the ship station would then switch to one of the regular Coast Guard high-frequency working channels.

"Many times the U.S. Coast Guard system couldn't get out as well as ours, and the mayday call would shift back to our working channels," comments one of the KMI radio operators serving the Pacific Coast. "We have such a huge antenna system that we hear and talk better than any other radio service around," added the technical operator.

Pulling The Plug

In mid-October, after several FCC-demanded delays, AT&T finally pulled the plug. All three stations are now off the air and can no longer be relied on for distress messaging.

"So who you going to call?" echoes Rohrs who once again starts to disassemble his marine SSB station.

For one thing, activating the new breed of Emergency Position Indicating Radio Beacons (EPIRB) on 406 MHz can start the search and rescue efforts anywhere in the world. The boat owner preregisters the 406 EPIRB with NOAA. When activated, the EPIRB can send this data to orbiting COSPAS satellites for a Doppler position fix.

There is also the newer GPIRB which also sends out an emergency signal along with the vessel's latitude and longitude to a geostationary satellite. Now, the search area may be confined down to the radius of a 300-foot circle!

But what about that old SSB rig? Leave it onboard, or give it to a *Pop'Comm* shortwave enthusiast who might not hear

much on the preprogrammed marine radiotelephone channels.

"Indeed marine SSB is on its way out," comments *Pop'Comm* reader R.D. Carter of Vass, North Carolina.

"Passenger ships have switched to large and costly gyro-stabilized satellite phone systems that may cost passengers \$10 a minute. Cargo ships carry computer satellite messaging equipment, which is one reason why big powerful public correspondence stations throughout the world are indeed signing off with their service," adds Carter. Carter points out that the same switchover could even trickle down to programmable VHF and UHF scanners that we all hear police and fire calls on, with digital trunked systems nationwide taking away from the ability to monitor the familiar voice of police and fire dispatchers.

"Even if you tune into military-affili-

ate radio service, high-frequency, single-sideband frequencies, you might hear check-ins, but chances are you probably won't hear any actual traffic because sailors using computers to send Internet communications do so by real-time satellite links, and no longer are doing it over high-frequency SSB voice circuits," adds Carter. He aptly points out that high-frequency skywave circuits are getting turned off by land stations who can no longer compete with satellite calls.

But boaters and sailors still have one high-frequency voice SSB station that is still on the air: station WLO MOBILE RADIO in Mobile, Alabama. WLO's Rene Stiegler reports that the station is trying to hang on as best it can during these troubled times.

"We still continue to offer voice marine SSB radiotelephone service, but only dur-



The ICOM marine SSB (upper left) was sold recently for \$300. New, it's a \$1,500 radio.

*U.S. Coast Guard Long-Range
SSB Frequencies*

ITU Channel	Ship Station (kHz)	Coast Station (kHz)
424	4134	4426
601	6200	6501
816	8240	8764
1205	12242	13089
1625	16432	17314

(All frequencies are USB)

ing daylight and evening hours; we are no longer 24-hours a day with a voice operator," reports Stiegler. However, WLO's Stiegler feels that slow, yet reliable PACTOR E-mail could be made profitable by public shore stations because it does not require constant vigil by radio operators, and can work quite well unattended and in the "automatic" mode once the ships and yachts register for the service. You can explore WLO's E-mail service further by logging on <rena@shipcom.com>, or calling Rene at 334-666-5110.

Well-known ham AIRMAIL provider K4CJX agrees that HF is indeed a good spot for an automatic E-mail station. It has been reported that his big ham E-mail set-up is going off the air and will be replaced by a marine frequency E-mail station where he can begin to serve the many mariners who use his system for *both* pleasure and commercial E-mail traffic. On ham E-mail, he could only allow non-commercial traffic to pass. There will probably also be a yearly registration fee, too, to offset all of the expenses he will incur when switching over from a pleasure station to a high-frequency marine station.

There is also PIN OAK digital marine E-mail service on the East Coast, Sail Mail E-mail marine radio service on the West Coast, and soon the Seven Seas Cruising Association (SSCA) may have E-mail down in the Florida/Gulf area; all stations operating on high-frequency, FCC-allocated, commercial E-mail frequencies.

But if a mariner *does* remove the HF SSB equipment, you should make every attempt to acquire this gear and use it successfully on ham HIGH FREQUENCY channels. Most high-frequency equipment is easily modified for ham radio use, and there is no FCC problems in taking a Part 80 marine SSB and using it on land as a modified ham set on ham frequencies with your present General or soon restructured 5 wpm General class license.

"I run an ICOM IC-M700 Pro on ham frequencies, and it works swell from 160 meters all the way up through 10 meters," comments Julian Frost, N3JF.

The Best Just Got Better!

The Eavesdroppers™ now includes our new Zap Trapper™ Electronic Gas Tube Lightning Arrestors. Receive-only design shunts damaging transients to ground at only 1/7th the voltage buildup of the available 200 watt transmit-type arrestors, providing maximum solid state receiver protection.

Protect your investment - combine an excellent shortwave receiving antenna with the best receiver protection money can buy.



- Completely assembled and ready to use
- Only 42" overall length
- 8 trap circuits permit reception on all shortwave bands, 11-90 meters.
- All connections soldered and enclosed in ultrasonically-welded, hermetically-sealed trap covers
- Includes 50' of 450 lb. test nylon rope

Model T includes 100' twinlead feedline

Model C includes weatherproofed center connector for your coax & coax sealant

- Either model \$79.95
- UPS for lower 48 states \$6.00
- COD add \$5.00, IL add 8.25% sales tax
- Foreign shipping quoted

Also Available:

- Eavesdropper™ Sloper - End-fed, coil-loaded receive-only antenna with underslung parallel element. Includes our Gas Tube Lightning Arrestor, 67 ft. overall length, \$79.95
- RCVR/T - Receive-only Gas Tube Lightning Arrestor for twinlead-fed antennas, two gas tube design, \$19.95
- RCVR/C - Receive-only Gas Tube Lightning Arrestor for coax-fed antennas, single gas tube design, \$19.95

Please Call For More Information.

Antenna Supermarket

P.O. Box 563 Palatine, IL 60078 Tel (847) 359-7092 Fax (847) 359-8161

At your dealer or direct • Visa & Mastercard accepted

He continued, "Some of the marine SSB transceivers showing up at marine swapmeets can work ham channels without even needing to lift the cover — such as the SGC 2000. Simply punch in the ham frequency of choice, punch in the upper or lower sideband mode, and get set for exciting voice operation with the General class ham ticket."

This same marine equipment will also work ham PACTOR quite nicely, as well as newer PSK modes, thanks to high-stability crystals found in all Part 80 marine SSB transceivers. A complete marine SSB transceiver system with the automatic antenna tuner sells for about \$2,000 retail. On the used market, ICOM, Kenwood, Furuno, Raytheon, SEA, and SGC high-frequency transceivers are seen selling for under \$300! Sometimes, you will also find them packaged with the automatic tuner for less than \$400! Some of this equipment is only a few years old, and almost all of these sets are synthesized for agile operation on ham and MARS frequencies.

All of these manufacturers are very much in business, and you can download details about the equipment by going to

their Web page under the manufacturer name.com.

"Although marine SSB radio equipment is about twice as large as comparable ham radio high-frequency transceivers, marine SSB still runs on common 12 volts DC, and an automatic antenna tuner isn't required if you have a dipole or pre-tuned antenna system on your roof," comments Bill Alber, WA6CAX, who scored several almost-new marine SSB transceivers for only a couple hundred dollars each at a local marine swapmeet.

"And many mariners will also advertise used marine SSB equipment in *Amateur Radio Trader* magazine, so you should always look up the classifieds for used marine high-frequency transceivers," adds Alber.

Most marine SSB transceivers offer 100 channels of user-programmable memory. This allows the licensed ham to keyboard-enter ham and MARS frequencies right on the front panel. Many marine sets don't even require any hardware modification to begin transmitting on ham nets.

Looking for a cheap HF transceiver? Start checking out the classifieds for used marine SSB sets! ■

clandestine communiqué

Tuning In To Anti-Government Radio

Colombian Guerrilla Station Expanding, And Hearing Burma Is Easy!

The station of the FARC guerrillas in Colombia, **La Voz de la Resistencia**, seems to be slowly growing and expanding. Sources now indicate that the station is operating at several different times and with programs aimed at different audiences or areas.

The station is on **6240** daily at 1100, 1300, 1700, 1800, 2000, and 2130. It also operates on **6170 (or 6095)** daily at 1130 and 2130 (to 2230). It's unclear, although probable, that the other transmissions mentioned above are one-hour in length and are intended for different areas or interests within Colombia or the regions controlled by the guerrillas. Opportunities to hear this low-power station in North America are mostly limited to the early morning and late afternoon segments.

One station which you *can* hear fairly easily is the **Democratic Voice of Burma**, which is currently scheduled from 1245 to 1345 on **5945, 15600, and 17750** and also from 1430 to 1455 on **9545, 11850, 21560, 17550, and 17750**. The broadcasts are in Burmese and other local languages and are sponsored by the National Coalition Government of the Union of Burma. The programming is aired via transmitters in Norway, Germany, Tajikistan, and Madagascar. The Voice of Burma answers correct reports with their own QSL card. Write to Democratic Voice of Burma, P.O. Box 6720, Skt. Olavs Plass, N-0130, Oslo, Norway.

The National Democratic Alliance (Sudan) operates the **Voice of Sudan**, operating from **0400 to 0600 on variable 8000 and from 1600 to 1800 on variable 8000 and 12004**. Broadcasts are also sometimes aired on 8000 between 1330 and 1500, all in Arabic. The NDA is an umbrella organization made up of several groups which oppose the present Sudanese government and is believed to be broadcasting from transmitters in Asmara, Eritrea, formerly part of Ethiopia. This station can often be heard in North America, although you have to beware of jamming coming from the Sudanese government station on or about the same frequencies used by the Voice of Sudan. The Voice of Sudan can be reached at the Sudanese National Democratic Alliance, 16 Cameret Court, Lorne Gardens, London W11 4XX, England.

Speaking of Eritrea, **The Voice of Truth** operates daily between 1430 and 1530 on **8020**. The broadcasts, in Arabic and the local Tigrigna language, are aired in support of the Islamic Salvation Movement, which seeks to replace the current Eritrean president with a Muslim.

Another station which wishes ill for the present government in Eritrea is **The Voice of Democratic Eritrea**, which also uses **8020**, and broadcasts from 1400 to 1430. It's a pretty easy guess that both of these stations are

using the same facility, the location of which almost has to be in Sudan.

The Voice of China is supposedly operated by a group calling itself the Foundation for China in the 21st Century, apparently with headquarters somewhere in California. The broadcasts are in Mandarin Chinese and are scheduled from 0830 to 0930 on **11940** and are aired via government transmitters in Taiwan.

Radio Freedom, the Voice of the Communist Party of Iraqi Kurdistan, operates in Kurdish on **3900 kHz variable** from 1600 to 1700.

The Voice of the Iraqi Communist Workers' Party also uses **3900** from 0300 to 0430 in Arabic and Kurdish, plus **3900 and 4755** from 1730 to 1900.

The Voice of the People of Kurdistan belongs to the Patriotic Union of Kurdistan and uses **4060 and 7000 variable** from 0345 to 0600, 1500 to 1900, and 2000 to 2100, in Kurdish and Arabic.

The Voice of the Movement of the Mojohedin of Iranian Buluchestan, broadcasts from official Iraqi government facilities in opposition to the government of Iran. It is on the air in Arabic and Baluchi from 1200 to 1300 on **variable 11785**.

The Voice of Palestine — Voice of the Palestine Islamic Revolution is on the air in Arabic from 0330 to 0430 on **11800 and 13660** and 1930 to 2030 on **9870, 9885, 11735, 11965, and 13645**. The broadcasts use the transmitters of Iranian government radio.

Here's a reminder that your clandestine radio news contributions are always most welcome — not to mention needed! We can always use loggings of clandestine stations, broadcast schedules of same, any information you may run across in the media about the organizations which operate clandestine stations, addresses and QSL information, and related information. Thanks for your continued interest and support.

Until next month, good listening! ■

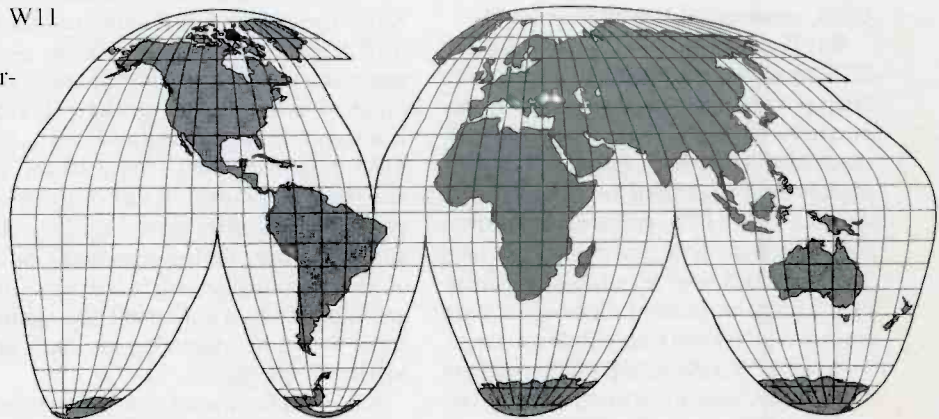

BY GERRY L. DEXTER

noise immunity even under adverse reception conditions. In addition to an AF input having a center frequency of up to 16 kHz, a separate input is provided to accommodate receivers with IF outputs of 12–1500 kHz. Parameters like input frequency and input sensitivity are directly controlled from the Windows GUI.

The price is \$1,733 and includes a free "shoc RadioSpectrumManager." VISA/Mastercard/American Express are welcomed. To order, or for additional information, contact shoc Inc., Gfell, CH-8499 Sternenberg, Switzerland, or call +41-52 394 12 55 or FAX +41-52 394 12 59. You can also E-mail <shoc@sales@shoc.ch> or visit the Website at <www.shoc.ch>.

RadioShack's New Sports CB Handheld

It has plenty of extra protection from the elements including protective gaskets to keep out dust, sand, and moisture and includes a detachable flexible antenna. This new TRC-238 40-channel handheld CB features a channel display that dims automatically to conserve battery power, a digital phase-locked loop (PLL) synthesizer for precise tuning, an automatic

noise limiter, a battery-test button, and jacks for adding optional base or mobile antenna and battery charger.

The unit requires nine "AA" alkaline batteries or 10 rechargeable NiCd "AA" batteries or adapter (not included). For more information on this new compact Sports CB radio (RadioShack Catalog No. 21-1670) from RadioShack that retails for \$99.99, contact your nearest RadioShack store or visit them online at <Radioshack.com>. Be sure to tell them you read about it in *Popular Communications!*

HF Spectrum Study No. 7

The newest Spectrum Study from the Electronic DX Press (EDXP) is now available. This covers the current (A99) international transmission season and contains the results of actual monitoring made in southeastern Australia during June 1999, from 0000–0400 UTC, for SW broadcasting stations on frequencies up to 9999 kHz.

The study is arranged in frequency order showing transmitter country, transmitter location, organization/station, observed reception span, observed sign-on and sign-

off times, languages, and other details. Several hundred entries are given in the EDXP study.

A description of propagation characteristics and effects of solar activity accompanies the data. The reception time period of 0000–0400 UTC corresponds to late morning until early afternoon in south eastern Australia, and the study includes many entries for broadcasts heard throughout that four-hour time span, extending across out local noon. Such propagation, from all continents, is noted every year during Australia's mid-winter period, and is known as the "Antarctic Mode" due to some signal paths crossing the Antarctic Region.

The Study is available as a Word 7.0 document, free of charge, which will be sent to you electronically on request by its compiler, Bob Padula, E-mail: <bpadula@compuserve.com>. Alternatively, users may prefer the printed version, offered at a cost of four IRCs (or U.S. \$3 cash), covering airmail delivery worldwide, from Bob Padula, 404 Mont Albert Road, Surrey Hills, Victoria 3127, Australia. For more information, contact Bob at the Electronic DX Press.

(Continued on page 78)

DEDICATED TO THE SCANNING AND SHORTWAVE ENTHUSIAST. WE'RE MORE THAN JUST SOFTWARE!

SCANCAT® GOLD for Windows "SE"

NEW!! JUST RELEASED!
VERSION 7.5.7

Since 1989, The Recognized Leader in Computer Control

Once you use SCANCAT with YOUR radio, you'll NEVER use your radio again WITHOUT SCANCAT!

SCANCAT supports almost ALL computer controlled radios by: AOR, DRAKE, KENWOOD, ICOM, YAESU and JRC (NRD) Plus PRO-2005/6/35/42 (with OS456/535), Lowe HF-150, and Watkins-Johnson.

SCANCAT GOLD FOR WINDOWS "SE" (Surveillance-Enhanced)

NOW SUPPORTS
UNIDEN BC-245 & BC-895
TRUNKTRACKER II
AOR AR16B - AR8200B
& TEN-TEC RX320

- Selective Sound Recording using PC-compatible sound card.
- "Point & Shoot" playback by individual hits.
- Demographic search for frequency co-ordination and 2way Usage Analysis.
- Detailed logging to ASCII type files with DATE, TIME, Sig Str, Air Time.
- 6 New sweep Analysis Functions.

With Scancat Gold for Windows "SE", your spectrum never looked so good! Load virtually "any" database and Scancat "SE" will examine your database, plot each and every frequency, no matter what the range...and "paint" the entire analysis on your screen.

SEVERAL GRAPHICAL ANALYSIS MODES AVAILABLE

- By Signal Strength per frequency in a "histograph".
- By Signal Strength plotted in individual dots.
- By Number of hits per frequency in a "histograph".
- IF THAT ISN'T ENOUGH, try this...Multicolored, 3-D "Spatial/Landscape".

SCANCAT GOLD "SE"...\$159.95 + S & H*

UPGRADE SCANCAT GOLD V7.5.7 "SE"...\$29.95 + S & H*

\$7.50 FOREIGN

SCANCAT'S WINDOWS FEATURES

- Unattended Logging of frequencies
- Scan Create Disk Files.
- Spectrum Analysis to Screen OR Printer.
- Supports PerCon, Mr. Scanner, and Betty Bearcat CD Rom's.

- Scan VHF & HF Icom's Simultaneously
- LINK up to 100 Disk files or ranges.
- MULTIPLE search filters for Diskfile Scanning.
- New - Programmable Favorite Frequency "Quick Buttons"

- Search by CTCSS & DCS tones with OS456/535 or DC440 (ICOM only).
- INCLUDES several large shortwave and VHF/UHF databases

All the features you EXPECT from a true Windows application such as:

- VEF-SATILE "Functional" spectrum analysis. NOT just a "pretty face". Spectrum is held in memory for long term accumulation. Simply "mouse over" to read frequency of spectrum location. "CLICK" to immediately tune your receiver. You can even accumulate a spectrum from scanning DISKFILES of random frequencies!
- DIRECT scanning of most DBASE, FOXPRO, ACCESS, BTRIEVE files WITHOUT "importing".
- UNIQUE database management system with moveable columns. Even SPLIT columns into doubles or triples for easy viewing of ALL Important data on one screen.
- Exclusive "SLIDE RULE" tuner. Click or "skate" your mouse over our Slide-Tuner to change frequencies effortlessly! OR use our graphical tuning knob.

SCANCAT GOLD FOR WINDOWS (NON-"SE").....\$99.95 + S & H*

UPGRADE TO V7.5\$29.95 + S & H*

*\$5 U.S. \$7.50 FOREIGN

MAGIC for Windows

PUT SOME ORDER
IN YOUR LIFE!

If You're Not Using MAGIC,
You're Only Enjoying Half The Hobby.

Magic is a super conversion utility that will read and write to over 10 database formats

- Creates databases from plain ASCII text.
- Finds single or multiple frequencies located anywhere in source files and creates perfectly aligned database files.
- Converts: SCANCAT, ASCII text, comma delimited, HTML, DBase, ScanStar, RadioManager and ScannerWear.
- NEW WINRADIO, "WRM" files and PCR1000 "MCH" files.

MAGIC for
Windows
\$34.95

(plus \$5.00 S & H)

LIMITED TIME OFFER!

Limited Time Thru 1/31/00

Scancat Gold for Windows \$99.95
Magic for Windows 34.95
Disk of Frequency Files 15.00
Regular Price \$149.00
SPECIAL \$124.95
For "SE" Add: \$59.95
"SPECIAL SCGM"

"UNI-VERSATILE" INTERFACE

- Supports ICOM/IC-R10, AR8000, AR16B, YAESU and SCOUT.
- Comes with 6 FOOT cable, and adapters to fit all units within a single package (Must Specify Yaesu)
- Unlike "single radio" adapters, can be used with ANY radio supported, simply change the adapter, then "Plug and Play."
- Expandable in future with a simple add on adapter.
- No external power required. Draws power from computer.
- "Reaction Tune" scout with NO modifications to radio.

CAT-232C "UNIVERSATILE INTERFACE"
\$99.95 + s & h



AR-8200B
Cables/Interfaces
—CALL!
BC-895 Cables
\$29.95

FREE FREQ FILES

WEB ADDRESS - www.scancat.com

FREE DEMOS



SCANCAT is a registered trademark
of Computer Aided Technologies.

Order direct or
contact your
favorite dealer

COMPUTER AIDED TECHNOLOGIES P.O. Box 18285 Shreveport, LA 71138

Phone: (318) 687-4444

FAX: (318) 686-0449

Info/Tech Support: (318) 687-2555 (9 a.m. - 1 p.m. Central M-F)

Toll-Free Orders
888-SCANCAT
888-722-6228

the pirate's den

Focus On Free Radio Broadcasting

Forget Y2K, Pirate Stations WILL Be On The Air!

Let's get going with another great crop of loggings. And remember, we can always use your pirate logs and QSLs.

WHYP, 6050 USB at 0305 with Ravi reading baseball scores and giving weather. (Hughes, MO) 0047 with Barry Manilow, mentions of Radio Zodiac, Gerry Barns, Radio Metallica. Host Robby Brownyard gave mail address. Off at 0058. (Tim Taylor, PA) 0054 to 0010 with clips of JTW and Dr. T; "I've fallen and I can't get up," Y2K, and Ravi giving temperatures. Also at 0330 with AL baseball scores, music from Afghanistan, NFL scores, Box Car Willie for JTA, song for FF of Radio Garbonzo. Also at 0106 with Joker's Wild by blue Radio (for Radio Bob), "Tiny Bubbles," etc. Also heard at 0115 while in Maryland with "Tiny Bubbles," "You're Never There." (Bill Finn, PA) **6949.8 USB**, 0320 with music and weather mentions by eastern-accented announcer. (Jerry Coatsworth, Ontario)

KIPM, (Illuminati Primus Materia), **6950 SSB** at 0220 with traffic 'copter report as society breaks down in Los Angeles, recurring end of the world theme. Heard many times over the week-end. Uses Lula maildrop. (Hughes, MO) Possibly this at 2330 with keyboard versions of familiar songs. Again, tentative, at 0500 with address as P.O. Box 24, Lula, Georgia 30554. Off at 0531. Religious programming. (Taylor, PA) **6955 USB** at 0638 with excerpts from space movies and "Outer Limits" TV show. The announcer was careful about pronouncing the "P" in the call. (William T. Hassig, IL)

Voice of the Runaway Maharishi, **6956 SSB** at 0058 with Andy Yoder interview from a TV show. (Hughes, MO)

Radio Metallica Worldwide, 6955 at 0219 promoting their relay service for \$10 and your show on a cassette to Blue Ridge maildrop. Also at 0313 with Weekend Music Marathon. Also on **6957**. (Hughes, MO) 0114 with female announcer talk, talk on terrorist subjects and politics, music from Dr. Tornado. Off

A.L International

pobox 663

7900 ar

Hoogeveen

The Netherlands

To: *Jon Oldenburg*

Hello dear radio listener. Here a QSL letter from Alfred [A.L. International]

Very nice that you heard us in the shortwave band.

And lots of thanks for the radio report.

Without them there is less fun in transmitting.

The first transmission was on 14-03-1998, on a saturday in the afternoon.

Then and still we use a transmitter that can go up to 140 watss, but most of the time we use low power.

The transmitter is one with valves :2x el84 and 2x os51 [pe1/100]

The antenna is a half wave dipole inverted V.

And for the modulation we use 2x 2vt4c valves 200/300 watss mod power

We don't have a regular program schedule.

But if you are looking for us you can find, us between 6200 and 6306 khz.

In the near future we look maybe for a exact spot, on 48 m.b aswel in the area of the 11 mhz

Till we hear from you again we wish you lots of health and joy

*ALL THE BEST FROM *ALFRED* [A.L. International]*

Date of transmission: 13-6-99 Time: 02:01 UTC

Frequency: 11.420 khz

Used power: 350 Watss

Remarks:

73's 51's And greetings from A.L International.

Sincerely yours : Alfred (a.l.)

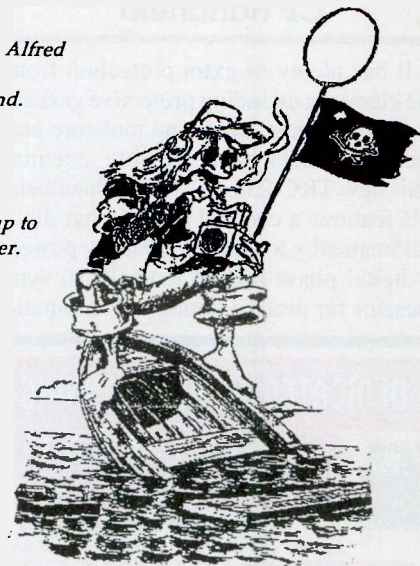

Jon Oldenburg of Wisconsin got this reply from A.L. International, based in The Netherlands.

with "Secret Agent" at 0141. Also at 0202 with ID, address, talk about nuclear power, Dire Straits tune, off at 0216. (Taylor, PA) 0144 to 0214 with Sr. El Nino hosting music but microphone pro-

ducing distortion. Also at 2326 with "Livin' Lovin'," "Two Tickets to Paradise." Wasn't Dr. Tornado or Sr. El Nino, although Tornado heard at the end. (Bill Finn, PA)

BY EDWARD TEACH

WBCT (tentative ID), **6955 SSB** at 0600 "to the West Coast and beyond." Hendrix and others. (Hughes, MO)

Radio Nonsense, 6955 SSB heard at 2315 with music and a skit. Off at 2317. (Taylor, PA)

Lights Out Radio (LOR), 6955 SSB, 6955 at 0331 with ID, sound effects of a lock down at a prison, man yelling "lights out!" Off at about 0355. (Taylor, PA)

Blind Faith Radio, 6955 SSB, with ID at 1553 and off. (Taylor, PA)

Lounge Lizard Radio (relayed by Radio Eclipse), 6950-52 SSB at 0059 requesting three postage stamps with reports, mention of it being program No. 4, address given as P.O. Box 28413, Providence, RI 02908. Off at 0105. (Taylor, PA) 0244 to 0259 with host Dean Soundgarden playing Dean Martin tunes. Sign off with "Volare." Also at 0035 to 0104 with Program 4 from the Hunsicker HiWay. Music by Buddy Rich, Mel Torme, Al Martino, Dean Martin. Close with "Volare." IDs by Bram Stoker and WLIS. Relayed by the incomparable Radio Eclipse. (Finn, PA) **6949.8 USB** at 0230, announced as Program 1. "Volare" interval signal. (Coatsworth, ON)

WAVI (tentative) **6955 SSB** at 0005 with ID, telephone number not copied, mention of "riding the waves" and then off at 0005.

Radio 3, heard on **6950 USB** at 0153 with ID, "babe" by Styx, said reports in care of the A*C*E. Announcer Sal Ammoniac. Off at 0211. (Taylor, PA) **6947 USB** at 0155 with Sal Ammoniac saying we "don't have a snowball's chance in hell unless we send QSL info to JR of ACE Dialogs" column.

WMPR, 6955 at 2249 with ID monitored at 2252, industrial music, and mention of "Micro Power Radio" at 2300 sign-off. (Taylor, PA)

WRMI — Radio Michigan International, 6955 SSB at 2335 with Smashing Pumpkins, theme from the Adams Family, a fake commercial for a margarine. Another time at 0224 with the operating talking about shortwave, long-wave and international broadcast bands, jamming techniques, ham operators, times station info. I've also heard this one using KRMI. Also aired a very profane skit. Off at 0236. (Taylor, PA)

Radio Zodiac/Radio Gary Moore, 6955 SSB at 0210 with song by Nirvana. ID at 0208 and off at 0215. (Taylor, PA)

WEED, 6955 USB at 0540 to 0624 with talk about drugs and pot. (Hassig, IL)

Radio 510 International, 6955 USB at 2237 to past 2310 with dance and Europop, German rock, Bill and Monica comedy bit. DJ's voice was distorted. He dedicated a tune to Andrew and Yvonne Yoder. Relayed via a North American pirate. Address given as P.O. Box 510, Basel 4010, Switzerland.

Finally, Stu Kinnaman, Indiana, notes hearing WRMI (the legit station in Miami) carrying former pirate **Scream of the Butterfly** at 0400 with host "Johnny in the North Atlantic." This seems to be an every-other-week broadcast.

That's it for this time. Thanks for all the logs. Keep tuning and keep 'em coming! ■



World's Most Powerful CB and Amateur Mobile Antenna*

Lockheed Corp. Test Shows
Wilson 1000 CB Antenna Has
**58% More Gain Than The
K40 Antenna (on channel 40).**

In tests conducted by Lockheed Corporation, one of the world's largest Aerospace Companies, at their Rye Canyon Laboratory and Antenna Test Range, the Wilson 1000 was found to have 58% more power gain than the K40 Electronics Company, K40 CB Antenna. This means that the Wilson 1000 gives you 58% more gain on both transmit and receive. Now you can instantly increase your operating range by using a Wilson 1000.

**Guaranteed To Transmit and Receive
Farther Than Any Other Mobile
CB Antenna or Your Money Back****
New Design

The Wilson 1000 higher gain performance is a result of new design developments that bring you the most powerful CB base loaded antenna available.

Why Wilson 1000 Performs Better

Many CB antennas lose more than 50% of the power put into them. The power is wasted as heat loss in the plastic inside the coil form and not radiated as radio waves.

We have designed a new coil form which suspends the coil in air and still retains the rigidity needed for support. This new design eliminates 95% of the dielectric losses. We feel that this new design is so unique that we have filed a patent application on it.

In addition, we use 10 Ga. silver plated wire to reduce resistive losses to a minimum.

In order to handle higher power for amateur use, we used the more efficient direct coupling method of matching, rather than the lossy capacitor coupling. With this method the Wilson 1000 will handle 3000 watts of power.

The Best You Can Buy

So far you have read about why the Wilson 1000 performs better, but it is also one of the most rugged antennas you can buy. It is made from high impact thermoplastics with ultraviolet protection. The threaded body mount and coil threads are stainless steel; the whip is tapered 17-7 ph. stainless steel. All of these reasons are why it is the best CB antenna on the market today, and we guarantee to you that it will outperform any CB antenna (K40, Formula 1, you name it) or your money back!

*Inductively base loaded antennas
**Call for details.

Lockheed - California Company

A Division of Lockheed Corporation
Burbank, California 91520

Wilson Antenna Company Inc.
3 Sunset Way Unit A-10
Green Valley Commerce Center
Henderson, Nevada 89015

Subject: Comparative Gain Testing of Citizen's Band Antennas
Ref: Rye Canyon Antenna Lab File #870529

We have completed relative gain measurements of your model 1000 antenna using the K-40 antenna as the reference. The test was conducted with the antennas mounted on a 16' ground plane with a separation of greater than 300' between the transmit and test antennas. The antennas were tuned by the standard VSWR method. The results of the test are tabulated below:

FREQUENCY (MHZ)	RELATIVE GAIN (dB)	RELATIVE POWER GAIN (%)
26.965	1.30	35
27.315	1.30	35
27.065	1.45	40
27.115	1.60	45
27.165	1.50	41
27.215	1.60	45
27.265	1.75	50
27.315	1.95	57
27.365	2.00	58
27.405	2.00	58

**58%
MORE
POWER GAIN
THAN THE
K40**

Individual test results may vary upon actual use.

CALL TODAY
TOLL FREE: 1-800-541-6116
FOR YOUR NEAREST DEALER

Wilson 1000

Roof Top Mount.....59⁹⁵ Little Wil.....29⁹⁵
Trunk Lip Mount.....69⁹⁵ Wilson 2000 Trucker .59⁹⁵
Magnetic Mount79⁹⁵ Wilson 5000 Trucker .79⁹⁵
500 Magnetic Mount .59⁹⁵ Call About Fiberglass!!!
Wilson 5000 BaseLoad — NOW AVAILABLE!

Wilson
ANTENNA INC.

A Division of Barjan Products, L.L.C.
East Moline, IL 61244

broadcast dxing

DX, News And Views Of AM And FM Broadcasting

A Beverage To Whet Your Appetite

The Beverage remains the antenna of choice for mediumwave DXers with the real estate and for DXpeditioners. This antenna is named after Harold H. Beverage, who first conducted transatlantic experiments with the wave guide design in the early '20s. The Beverage antenna is simply a straight wire, minimum one wavelength long, terminated with a resistor to ground at its far end. The direction of the wire from the receiver connection is the direction of reception. The wire only has to be a couple of feet above ground. If the wire is too high, then it tends to lose some of its tight directional characteristics. Low to the ground, the Beverage is highly unidirectional, and ideally suited for low angle reception of mediumwave signals over long distances.

Because the number of skips of a mediumwave signal is limited, the longest distance signals generally arrive at low angles. The terminating resistor value varies based mostly on ground conductivity, but is typically around 500 ohms. A potentiometer can be used to fine-tune the termination for optimum performance at the desired frequency. As frequency decreases, wavelength increases. For mediumwave reception, the length of the wire should be calculated according to the longest wavelength or lowest frequency, which is 530 kilohertz. To cal-

culate the wavelength in feet, divide 984 by the frequency in megahertz. 530 kHz is the same as 0.530 MHz. 984 divided by 0.530 equals about 1857 feet. Now you know why the real estate is needed.

Some DXers use what has become known as the mini-Beverage, essentially a terminated longwire antenna that may perform as a true Beverage antenna only at the high end of the mediumwave band. For example, wavelength at 1000 kHz is half that of 530, which is a good compromise for wire length. When it comes to Beverages, longer isn't always better. In theory, wire length shouldn't exceed four times the wavelength. There are other hazards as well. At a Newfoundland DXpedition, the results of a wire estimated to be over a mile long were inconclusive after it was discovered that a moose had crossed its path, dragging the wire off course. Lightning safety should be taken seriously when using extremely long wires. Lightning strikes are common even at shorter wire lengths for tropical band shortwave Beverages.

Graveyard DX Test Results

With the new DX season underway, listen for stations conducting equipment tests in the early morning hours, especially on Sunday and Monday mornings. Radio stations often coordinate testing

with DX clubs, as these tests often include changes in power and antenna patterns, giving DXers extraordinary opportunities for some rare catches.

Allan Loudell, Program Manager for WILM, reports that last year's DX test was a success. WILM Wilmington, Delaware, at 1450 kHz was heard as far away as Alabama, Indiana, and Ontario. This is especially remarkable because 1450 is what's known as a *graveyard channel* due to the number of stations on the frequency. There are over 200 radio stations "buried" on 1450 in the U.S. and Canada. Most are non-directional and 1,000 watts full-time, the maximum power allowed by the FCC.

Frequencies **1230, 1240, 1340, 1400, and 1490** kilohertz are also graveyard channels. Many stations will prepare special programs for DX tests, including Morse code identifications that can pierce through interference. "1450 WILM Newsradio" replaced overnight talk with music, code IDs, and sirens for last year's test. Interestingly, Allan writes, "While the Morse code tones and sirens got out the best, one particular 1970s rock song penetrated the massive interference, at least with a few DXers at intermediate distances; "Hocus Pocus" by the Dutch group Focus. WILM has been issuing a "Millennium QSL" for reception reports. The address is P.O. Box 1990,

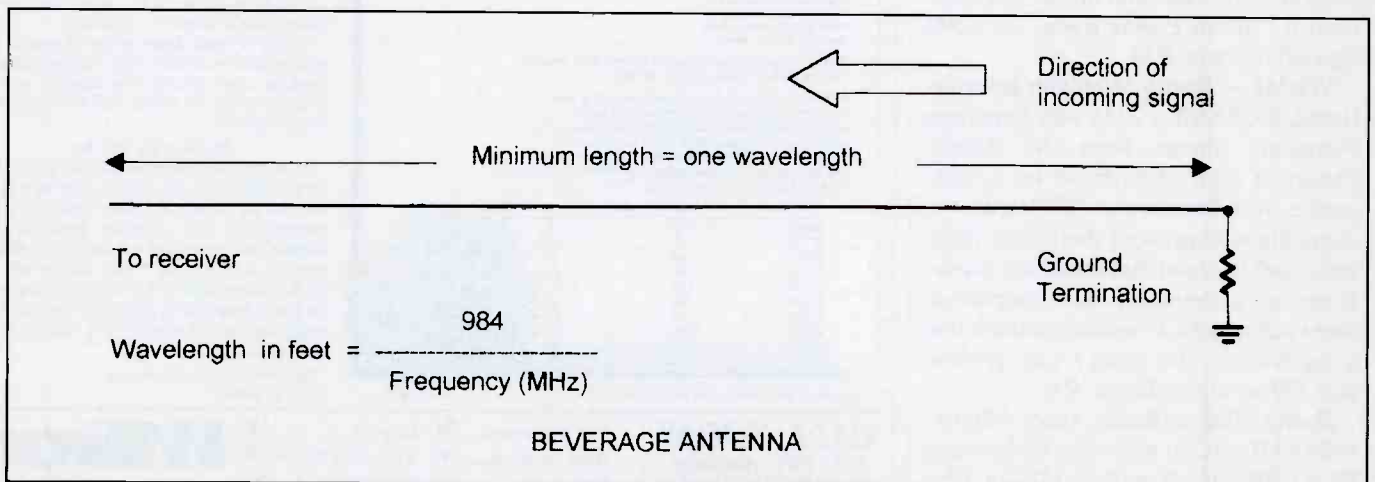

Diagram of a Beverage antenna.

BY BRUCE CONTI <BAConti@aol.com>

Wilmington, DE 19899-1990. Don't forget to include return postage. For the latest DX test schedule, visit the International Radio Club of America Website at <www.geocities.com/Heartland/5792>.

The graveyard channels can produce some interesting catches during regular broadcasts as well. During the critical sunrise and sunset transition periods, you never know what might pop up, so always keep a tape recorder going just in case. Receptions over thousands of miles can occur during these critical hours. The National Radio Club maintains a list of graveyard DX achievements that documents record distances of reception for individual stations and DXers. Visit the NRC Website at <www.nrcdxas.org> to check out some of the amazing BCB distance records.

AM Stereo Enthusiasts

A core of AM stereo enthusiasts is emerging to become a more vocal segment of radio listeners. There is now an E-mail list for fans of AM stereo. The URL is <<http://amstereo.listbot.com>>. Unfortunately, many radio stations seem to be dropping AM stereo, just as they are dropping music formats in favor of news, sports, and talk. List moderator Bryan Turner recommends WSM Nashville at 650 kHz as a good AM stereo test station. Another website, The AM Stereo Page, includes information about radio stations broadcasting in AM stereo, and where to find AM stereo receivers and converters. One unique adapter described on the site receives the AM stereo signal and converts it to FM for listening on any home stereo. Visit <www.amstereoradio.com> for more information.

News In Brief

Howard Stern may have gained a few new listeners in the Portland, Oregon, area after they heard the monthly Emergency Alert System test. Instead of the regular announcement, "This is a test of the Emergency Alert System..." every station broadcast a 20-second promo for The Howard Stern Show, followed by the alert tones. The test originated from KUFO 101.1 FM.

San Diego has a new country music station from south of the border. XHCR Tijuana "Hot Country Radio" debuted on 99.3 FM. This is after two San Diego FMs recently switched to Spanish formats to compete with popular Mexican outlets.

A surge in the ratings for WBOS Boston

at 92.9 prevented their adult rock format from getting the axe in favor of talk radio. Instead, sister station WSJZ 96.9 Smooth Jazz dropped music to become WTTK "Ninety-Six Nine FM Talk," Boston's first talk station on FM. WBZ Newsradio 1030 continues to hold the overall lead in the Beantown ratings race.

WEEU has completed the switch from 1 kW at 850 to 5 kW at 830 kHz. The sta-

tion now operates from new towers at a new site in Upper Bern Township, Pennsylvania. A new shopping mall will occupy the old four-tower directional antenna site.

The Falkland Islands are the hot DX target of year. Rocco Cotroneo of Hard Core DX reports that the new Falkland transmitter on 530 kHz is booming into Rio de Janeiro, Brazil, at night. The chal-



CALL TOLL FREE
(800) 292-7711
Orders Only
Se Habla Español

C&S SALES

Order On-Line @ www.cs-sales.com

CALL, E-MAIL OR WRITE FOR OUR FREE
64 PAGE CATALOG!
(800) 445-3201

Digital Multimeters

<p>Elenco Model M-1740</p>  <p>\$39.95</p> <ul style="list-style-type: none"> • 11 Functions • Fixed to 20MHz • Cap to 20µF • AC/DC Voltage • AC/DC Current • Diode Test • Transistor Test • Meets UL 244 safety specs Model M-2760 - \$24.95 (9 functions) 	<p>Elenco Model LCR-1810</p>  <p>\$99.95</p> <ul style="list-style-type: none"> • Capacitance 10pF to 20µF • Inductance 1µH to 20H • Resistance 0.1Ω to 20kΩ • Frequency 0.1 to 200C • DC Volt 0.20V • Frequency up to 15MHz • Signal Generator • Continuity Test • Signal Output Function • 3 1/2 Digit Display 	<p>Fluke 87III</p>  <p>\$319</p> <p>Features high performance AC DC voltage and current measurement, frequency, duty cycle, resistance, conductance and capacitance measurement</p>
---	---	---

Elenco Oscilloscopes



Free Dust Cover and x1, x2 Probes



2 year Warranty

S-1325	25MHz	Dual Trace	\$325
S-1330	25MHz	Delayed Sweep	\$439
S-1340	40MHz	Dual Trace	\$475
S-1345	40MHz	Delayed Sweep	\$569
S-1360	60MHz	Delayed Sweep	\$749
S-1390	100MHz	Delayed Sweep	\$995

Generators and Counters

<p>Elenco Sweep Function Generator with built-in frequency counter Model GF-8036</p>  <p>\$229</p> <p>This sweep function generator with counter is an instrument capable of generating square, triangle and sine waveforms, and TTL, CMOS pulse over a frequency range from 0.2Hz to 25MHz.</p>	<p>Elenco Handheld Universal Counter Model F-2800</p>  <p>\$99</p> <p>Features 10 digit display, 16 segment and HI signal strength bargraph. Includes antenna, Ni-Cd battery and AC adapter. Resolution to 10Hz.</p>	<p>B&K Frequency Counter Model BK-1875</p>  <p>\$189</p> <p>50Hz - 2.8GHz 3 Channels</p> <p>Sensitivity: -100mV @ 100kHz -50mV @ 300kHz -27mV @ 1MHz -400mV @ 30Hz</p> <p>Ultra sensitive synchronous detector bargraph and RF strength.</p>
---	---	--

Elenco RF Generator with Counter Model SG-9500



\$225

Features variable AM mod of 10Hz, RF output 100Watt - 100MHz. Audio output 1Watt @ 1V RMS. SG-9500 (analog, w/o counter) \$124

Elenco 10Hz - 1MHz Digital Audio Generator Model SG-9300



\$225

Features built in 150MHz frequency counter, low distortion and sine/square waves. SG-9200 (w/o counter) \$124

Tekk Radios

Pro-Sport FRS Two-Way Radio Model PRO-SPORT+



\$79 each or \$125 Set of 2

- 14 Channels
- Battery Monitor
- Key Lockout
- Monitor Button
- Lightweight
- Palm Sized
- Large LCD Display
- Removable Belt Clip
- Removable Antenna
- Two Radio Call Tones
- Busy Channel Lockout
- Accessory Connector
- Highly Water Resistant

PRO SPORT Model \$109.95 set of 2

Four Functions in One







\$459

Features:

- One instrument with four test and measuring systems:
- 1.3GHz Frequency Counter
- 2MHz Sweep Function Generator
- Digital Multimeter
- Digital Triple Power Supply - 0.30V @ 3A, 15V @ 1A, 5V @ 2A

Elenco Educational Kits

<p>Model AR-2N6K</p>  <p>\$34.95</p> <p>2 Meter / 6 Meter Amateur Radio Kit</p>	<p>Model AM-780K</p>  <p>\$11.95</p> <p>2 IC Radio Kit</p>
<p>Model M-1005K</p>  <p>\$19.95</p> <p>Digital Multimeter Kit</p> <ul style="list-style-type: none"> • 18 Ranges • 3 1/2 Digit LCD • Transistor Test • Diode Test 	<p>Model RCC-7K</p>  <p>\$29.95</p> <p>Radio Controlled Race Car Kit</p>

Guaranteed Lowest Prices

UPS SHIPPING: 48 STATES 5%
OTHERS CALL FOR DETAILS
IL Residents add 8.25% Sales Tax

SEE US ON THE WEB

C&S SALES, INC.

150 W. CARPENTER AVENUE
WHEELING, IL 60090
FAX: (847) 541-9904 (847) 541-0710
<http://www.cs-sales.com>
e-mail: sales@cs-sales.com

15 DAY MONEY BACK GUARANTEE
2 YEAR FACTORY WARRANTY

PRICES SUBJECT TO CHANGE WITHOUT NOTICE

www.popular-communications.com

January 2000 / POP'COMM / 47



1450 WILM

NEWS RADIO

WILMINGTON, DELAWARE
U.S.A.
MILLENNIUM QSL

WILM's Millennium QSL card.

lenge for North American DXers will be to null out Radio Vision Cristiana from Turks & Caicos, and CIAO Toronto, both on 530.

QSL Information

1539 5TAB Adelaide, Australia, received a full detailed QSL card in 19 days for taped report, signed by E.G. Gesler. The address is Tab Building, Level 1, Pulteney Court, Adelaide 5000, S.A. Australia. (Martin, OR)

1590 KUNX Ventura, California, letter in 16 days, signed Chip Ehrhardt GM. Sent taped report to Gold Coast BC, 715 Broadway, Ste. 320, Santa Monica, CA 90401 and received QSL from: 2284 Victoria Avenue, Ste. 2G, Ventura, CA 93003. MW QSL 2596. (Martin, OR)

1620 KAZP Bellvue Nebraska, verification letter signed by Stephen D. Claasen, Director of Engineering. Address: 1001 Farnam-On-The-Mall, Omaha, NE 68102. (Jackson, CA)

1650 WHKT Portsmouth, Virginia, verification letter signed by Doug Stewart. Address your report to 2202 Jolliff Road, Chesapeake, VA 23321. (Jackson, CA)

Broadcast Loggings

This month's selected logs begin with some unusual TV DX in Boston, Massachusetts. Robert Moody reports receiving CBHT Nova Scotia on channel 11. "I picked up a test pattern on channel 11 from Halifax using a Zenith TV of recent vintage and an indoor antenna,

beginning around 0600 UTC. At 1200, the channel was taken over by WENH Durham, New Hampshire. I called the CBC in Toronto and they gave me the phone number of the station's engineer in Nova Scotia. He was surprised the signal reached Massachusetts, but attributed it to unusual atmospheric conditions. New York City and Portland, Maine, often can be picked up here in the summer, but this is the first time I ever received a rather good signal from Canada."

Congratulations Robert, as TV from the Canadian Maritimes is indeed a rarity.

Patrick Martin kicks off the AM logs with a good run on the Philippines. All times are UTC.

531 Philippines, talk in Tagalog mixed JOQG Japan at 1407. (Martin, OR)

700 RJR Montego Bay, Jamaica, fair heard at 0300 with RJR 92 FM ID and DJ rap-style reggae music, in WLW null. (Conti, NH)

720 DYOK Iloilo City, Philippines, very good and all alone on the channel at 1330 with many spots, some in Tagalog, others in English, even a mention of DZRH (mother station at 666 kHz), and DYOK IDs. Totally armchair copy for quite a while. (Martin, OR)

828 DXCC Cagayan De Oro, Philippines, tentative with old U.S. pops and slow announcer in Tagalog, mostly buried by JOBB Japan at 1334, has been heard here a lot through the years. (Martin, OR)

840 CHMW Dobleve, Santa Clara, Cuba, good at 0100, "Esta es Dobleve, desde Santa Clara en el centro de Cuba"

and "CHMW presenta..." tropical music program. (Conti, NH)

882 DWIZ Navotas, Philippines, heard very poorly with "D-W-I-Z" ID by a man, into song "Second Hand Rose" at 1347. (Martin, OR)

1020 KCKN Roswell, New Mexico, with a blaster signal at 0826 and Bruce Williams talk. (Kelly, AZ)

1030 KTWO Casper, Wyoming, at 0844 with KCKN periodically splattering over from 1020, local ads and country music. (Kelly, AZ)

1044 Sebaa-Aioun, Morocco, at 2310 with Afropop-style music with melodic guitar-like instrumentation resembling that in the Paul Simon "Graceland" album. Signal was absolutely local-like, almost pinning the S-meter and totally blowing out Spain. (Connelly, MA)

1062 DZEC Quezon City, Philippines, good with "Fleetwoods" song and man with "DZEC" ID at 1358. (Martin, OR)

1206 R. Bleue, Bordeaux, France, at 2151 a folk vocal, woman and man in French, then the "Banana Boat Song" by Harry Belafonte, very good to S9+20. (Connelly, MA)

1210 KGYN Guymon, Oklahoma, with a faint, but intelligible signal at 0923, Agrinet IDs, farm news reports, talk about grain and livestock, and country music. (Kelly, AZ)

1296 DXAB Philippines, with Network programming in Tagalog from 1345-1358, end of network programming at 1355 with "D-X-A-B" IDs and "ABS CBN" Network, faded down in the mud by 1402. Does anyone know the location of this one? Any help would be appreciated. (Martin, OR)

1310 KIVA Corrales, New Mexico, at 0837 with beautiful music including Percy Faith's "Theme From a Summer Place." Interference from KXAM Arizona also on 1310 nulled when the radio was rotated 90 degrees off of KXAM direction. (Kelly, AZ)

1660 KRZX Waco, Texas, at 1200 heard with news and weather on a weak signal through KXOL. (Jackson, CA)

1680 WTIR Winter Garden, Florida, at 0030 with a "radio frequency test," heard on the car radio tonight in NJ with excellent signal strength. Several spots and IDs as "Traveler Information Radio." (Ort, NJ)

Thanks to Ken Betsh, Mark Connelly, Bob Gilbert, Gary Jackson, Nile Kelly, Allan Loudell, Patrick Martin, Robert Moody, Harold Ort, Craig Pattillo, and Bryan Turner. 73

scan tech

Trunking, Tips, Techniques, And Mods

Radio And Computer Connections, Part II

I frequently get letters asking how to connect this or that radio to the computer to do memory uploads, computer control, or even logging. Unfortunately, I don't have a library of ready-made solutions. If you'll remember, a few months back, we looked at the basic requirements for getting the radio and computer to talk to each other, and based on that information, with some examples this month, I'm hopeful that we can get you going on your own.

If you'll remember, or for those who just joined us in the last couple of months (or possibly if you didn't read my column in November), let's do a quick refresher. You'll need four things to make a worthwhile computer/radio connection, regardless of what you want to accomplish.

You'll need a computer-controllable radio. Most of the time, that means that you'll need a radio that came from the manufacturer with a computer interface or at least the option of installing one later. Remember that a few add-on third party computer interfaces are available for the PRO-2005/2006 and PRO-2035/2042 line from Optoelectronics and others. Otherwise, you'll need a computer-controllable receiver.

You'll need the computer. Remember that all radio interfaces so far, require a serial interface, so an empty RS-232 port is essential. You don't necessarily need or want a state-of-the-art 500 MHz machine. Some of the older DOS applications run just fine, or better, on an old 486 machine that can be bought for less than \$100. Even the Windows systems run just fine on 150-200 MHz machines which are also coming down in price on the used/refurbished market.

You'll need an interface. That's the device that converts the signals from computer levels to radio levels electronically. Many computer-controlled radios include the interface as a part of the system and no extra hardware is necessary, but some do not. Make sure you have what is required before trying to hook anything together.

And finally, you'll need software. Software will dictate what capabilities you have and the functions available. Some systems, like the Optocom and OptoScan series, ICOM radios, and the AOR series handhelds have been so popular that many software choices are available. Others have only a limited number of applications on the market. You'll have

to make sure that the software you choose supports the radio you have, unless you're willing to go shopping for a new radio as part of the total package.

Hopefully, you still have the November issue lying around to refresh your memory if you have any other questions. If not, it's available as a back issue from *Popular Communications* at 516-681-2922 or FAX 516-681-2926. Check with them for pricing and availability information. In the meantime, let's get started with some specific radios.

AOR's AR-8000

The connection for the AR-8000 is already built into the radio, but located in a rather inconvenient spot: inside the battery compartment — and it uses a totally strange (for us in North America) — connector. You'll have to remove the battery cover to access the port when you wish to connect the radio, or cut a hole in your battery cover so that it's available all the time. I only use the computer interface when I want to reprogram memories (a computer-assist application), so I just remove the battery pack.

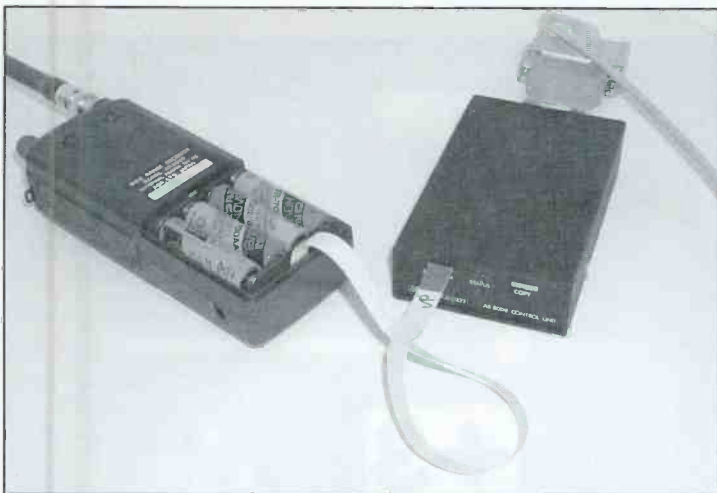

This is the interface unit from AOR. Note the adapter necessary to convert the Macintosh to Modem cable down to the 9-pin configuration required for the interface. Also note the unusual placement of the connector on the radio.

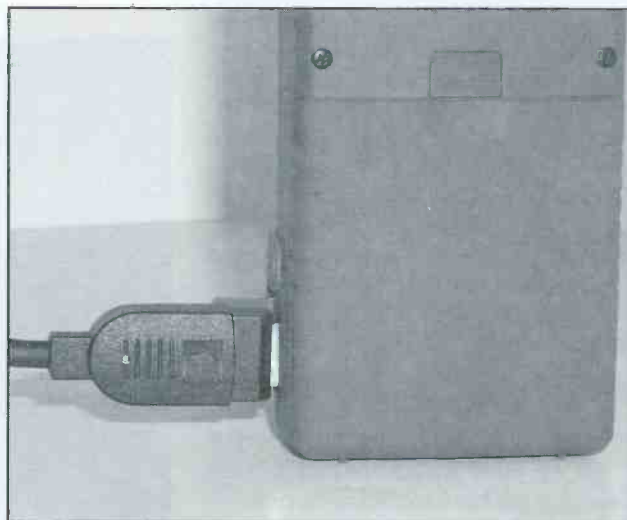

Here's a much more sensible connector on the new AR-8200. There's a rubber cover that keeps dirt out when the connection is not in use.

BY KEN REISS <armadillo1@aol.com>

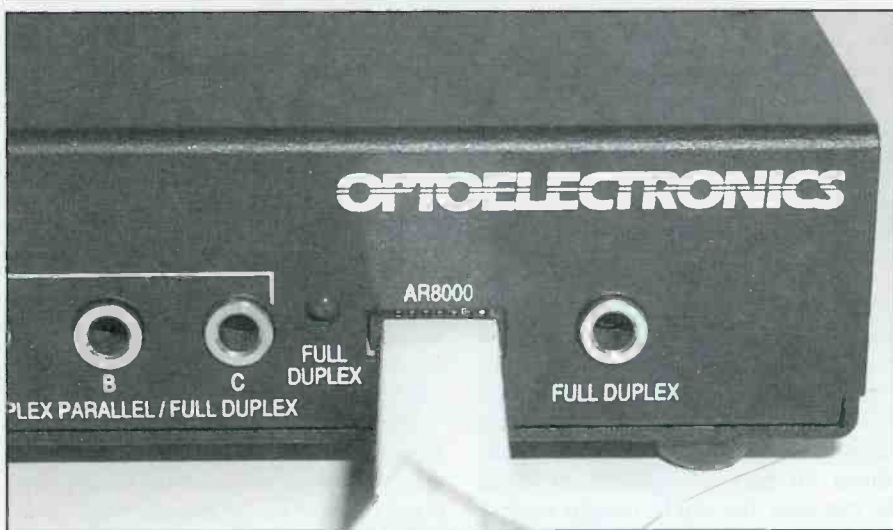

Here's another, much more versatile interface that also supports the AR-8000. The Optoelectronics Optolinx interface has a dedicated connector for the 8000's ribbon cable, but can also support many other radios including ICOM and AOR. If you need an interface unit for more than one radio, or for an ICOM receiver in general, I highly recommend this unit.

Partly because of this strange connector, and partly because of how the radio is designed, you'll need an interface unit. Many are available from all sorts of sources. Computer Aided Technologies makes a popular one, and AOR makes one (which is the unit I have). Optoelectronic's Optolinx also supports the AR-8000, in addition to a whole host of other radios. Shop around and see what else you can find.

The actual connection is fairly simple once you have all the pieces. I've chosen a Macintosh program, just so the Apple folks won't feel left out, but a serial port connection on a Windows PC to the interface would do the same thing. Mac users can use an Apple Modem Cable to go from the 8-pin RS-422 connection on the back of the computer to the interface. Sorry, new blue G3 and Imac users not included — no serial ports. What were they thinking? They were thinking USB, but the radio world hasn't caught up yet. Some good news, although I haven't tried it yet, is that a few third party companies are coming out with USB-to-serial converters, so it may be possible soon.

The AR-8200

The AR-8200 is a bit updated, and the connector has been moved to the outside. The cable required, however is still not a standard cable so you'll have to make sure you get one made for the 8200. AOR supplies one with their software package, but others are available. The cable plugs into

a PC's RS-232 port at one end and the radio at the other. There is no need for any external interface devices.

More and more software is being released for the 8200 all the time. Many shareware and commercial applications support this popular radio. The AOR software, AR-8200 Workshop, is being updated fairly regularly and has become a very functional package, although some find it cumbersome to use. A program worth checking out for sure if you have an 8200 is ARC-8200 from BuTel software in the Netherlands. It's got a demo available at <www.butel.nl>. Of course,

most of the time with a handheld, I'm assuming you are mostly interested in memory upload/download capabilities.

AOR's AR-3000

I believe that many of the AR series of base radios had a computer connection, but I am only sure about the 3000 and 3000A, since I've worked with those two. It's a very simple matter to go from the RS-232 connection on the computer to the 25 pin connection on the back of the radio. While you're on the back panel, don't forget to flip the "remote" switch to activate the computer control.

ICOM Radios

Most ICOM desktop radios support some sort of computer interface. There is a little variance in what the interface supports (for instance the 7000 does not return squelch status through the interface and therefore a special connection is required for maximum performance, while the IC-R9000 supports remote volume and squelch control). The recent IC-R8500, and the black box radios (PCR-100 and PCR-1000), of course, have computer interfaces built right in. All that's necessary for these units is a cable to the RS-232 port.

On the older receivers, you'll need an interface box of some sort. ICOM developed a system called CI-V (Communications Interface-Five (Roman Numeral)) which allows for one RS-232 connection to support multiple radios. Kind of like a

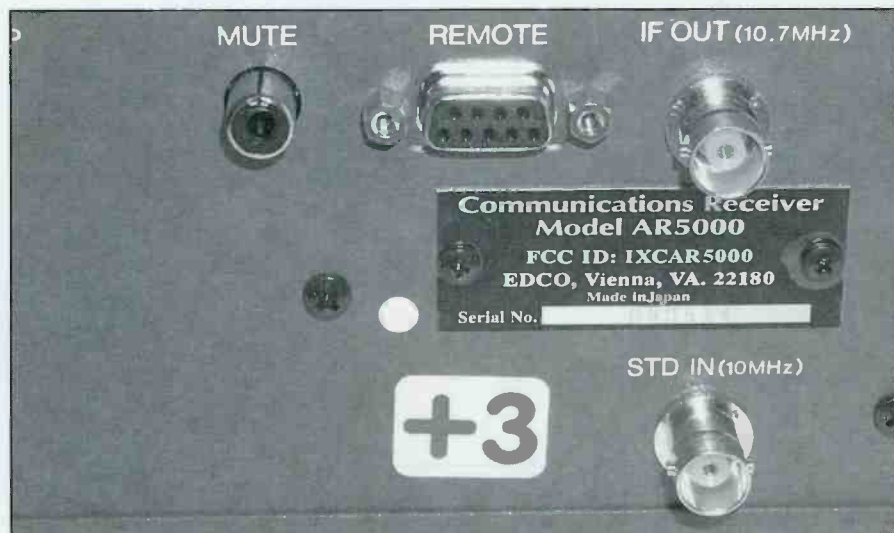

Today's communications receivers all have computer interface capabilities. Here's the rear panel of an AR-5000 Plus 3, which can hook directly to a COM port and you're all set. Add software and stir.

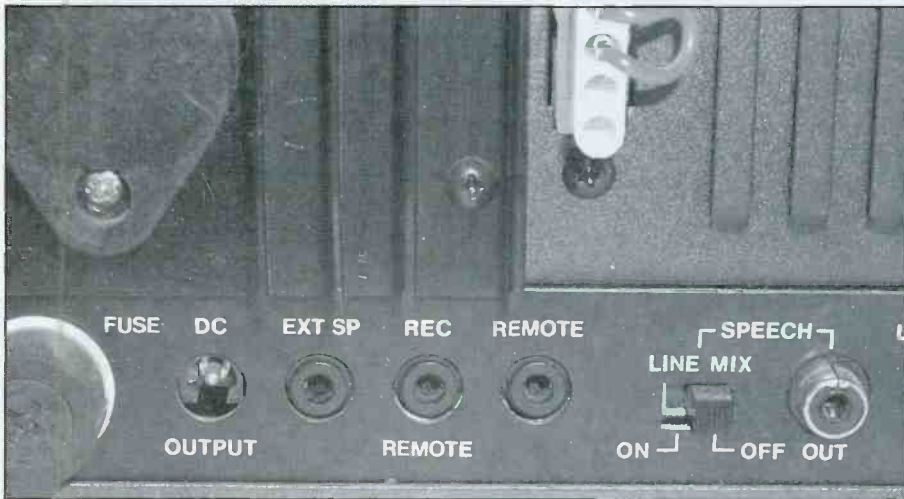

Many ICOM receivers call the computer interface the "remote" connector. A CI-V interface is required to hook this R-9000 to a computer, but here again the Optolinx will work great.

computer network for radio control, and if you have multiple ICOM or CI-V receivers, you can do some neat stuff if your software supports it. ICOM makes a control box for this called the CT17, but Optoelectronics' Optolinx also provides full ICOM support, as well as support for a number of other radios. If you need one of these interfaces, I highly recommend the Optolinx because of its versatility.

The connection is relatively straightforward, once you have all the pieces. Go from the RS-232 port on the computer to the computer input on the CI-V interface or Optolinx. On the ICOM interface, a 25-pin connector is used, but on most third party units, a more standard (these days) DB-9 is required. Adapters are available to go either way depending on the cable and jack that you have.

Then, an audio cable (mini phone plug (1/8 in) to mini phone plug) is required to go from the interface to the CI-V jack on the radio. Note that the Optolinx can also use a stereo mini plug for certain radios, but on the ICOM there is no particular advantage to doing so.

The IC-R8500 has an interface built right in. An RS-232 connector (25 pin) is supplied on the back of the radio, along with a CI-V connection. The radio can be connected either way, or you can use the 8500 as the first in a chain of CI-V controlled radios.

The PCR-1000 and PCR-100 are, of course, dedicated computer-controlled receivers and won't do much of anything without a computer connection. These radios have an RS-232 port on the back and come supplied with a cable and software for quick setup and operation.

Many applications support the CI-V protocol, so you won't have any shortage of software. One that does a particularly good job from a scanner point of view is ScanStar Deluxe. It also provides great support for multi-radio configurations and is worth a look. They have a demo that you can download from <www.scanstar.com>. Also, check out ScanCat Gold at <www.scanecat.com>, as this program supports a number of radios and protocols and some people find it easier to use. Radio Manager for Windows <<http://www.interplaza.com/bensware/rm.htm>> is also a nice shareware program for ICOM control. If I've left out your favorite, I apologize, but there are so many that support these radios, that it's virtually impossible to list them all, much less be familiar with them. If you have one of these receivers, and are looking for

software, shop around a bit — there's a myriad of choices.

PRO-2005/2006/2035/2042

These popular RadioShack scanners did not come with a computer interface from the factory, but a couple of third party add-on systems have been made available to get these radios under computer control. The most popular is the OptoScan series from Optoelectronics, but there are a few others depending on what you want the interface to do. The CE-232 and PRO-Grammit interfaces <<http://www.qsl.net/ka2pyj>> allow direct programming of the radio, which the Opto series does not. Outside of that, if you're interested in computer control and not memory loading, you'll want the OptoScan unit for your radio.

Getting the interface installed is a bit beyond the space limitations of this article. I'm not complaining about that mind you, because the last time I did, ol' "I need 500 more words Harold" doubled the size of my column! We did address installing the OS-456 board in a PRO-2006 in the November '98 issue of "ScanTech." Hmm . . . November seems to be computer month around here.

Anyway, it is worth noting that the Optoscan interfaces come in two varieties. The OS-456 lite (the only one still available) fits the PRO-2005 and PRO-2006 radios. It does not support tone squelch or signal strength like its older cousin, the OS-456, or the OS-535 board, but it does offer an excellent way to get into computer control if you already have one of these radios. It's available for less than \$100 directly from Optoelectronics.



The computer-controlled receivers from ICOM, however, use their own protocol, and that includes a built-in interface. The cable is supplied, so you're all set with these receivers.

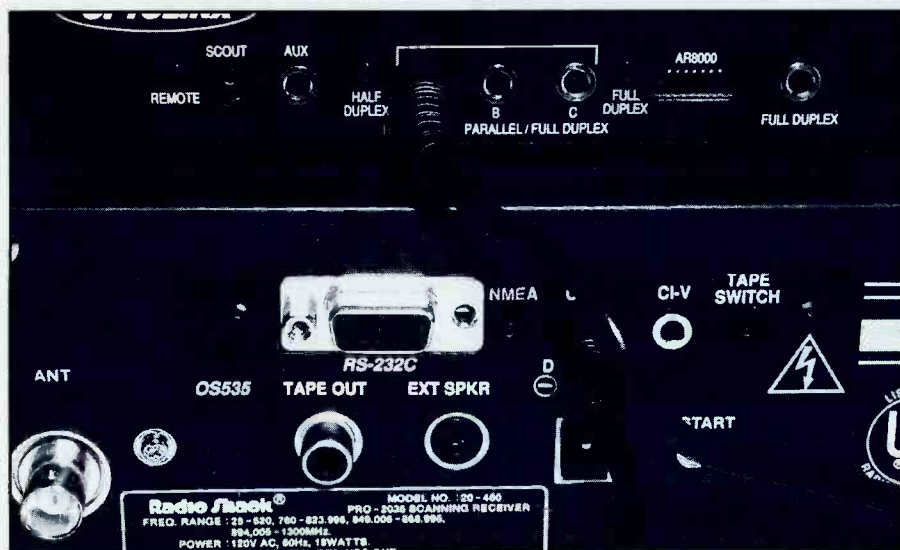

The OptoScan interfaces for the popular PRO-2005, PRO-2006, PRO-2035, and PRO-2042 (shown here) have a direct interface connection to the computer and a supplied cable. However, in a multi-radio environment, you might also want to use the CI-5 connection and an Optolinx interface. ScanStar, in particular, supports this configuration and can do amazing things with multiple radios.

The OS-535 board fits the newer PRO-2035 and PRO-2042 radios. Of course, all of the radios have been discontinued in the U.S., but you might find one on the used market, or overseas markets may still have a few floating around.

In either case, once the interface is installed in the radio, you need a cable (supplied with the interface) to connect the RS-232 port from your computer to the RS-232 port on the radio and you're all set. If you prefer, a CI-5 port is also available and can be used with most software to control multiple radios. Note that Optoelectronics' protocol is CI-5 not CI-

V. The subtle difference reflects that Optoelectronics has expanded the basic CI-V protocol developed by ICOM and supports many more functions as well as full-duplex communications (with stereo plugs from the interface to the receiver) on some radios.

There is probably more software available for the Optoscan units than virtually any other computer controlled system, with the possible exception of ICOM since they've been available much longer. Optoelectronics was very quick to release their protocol to developers and they responded with a wide variety of appli-

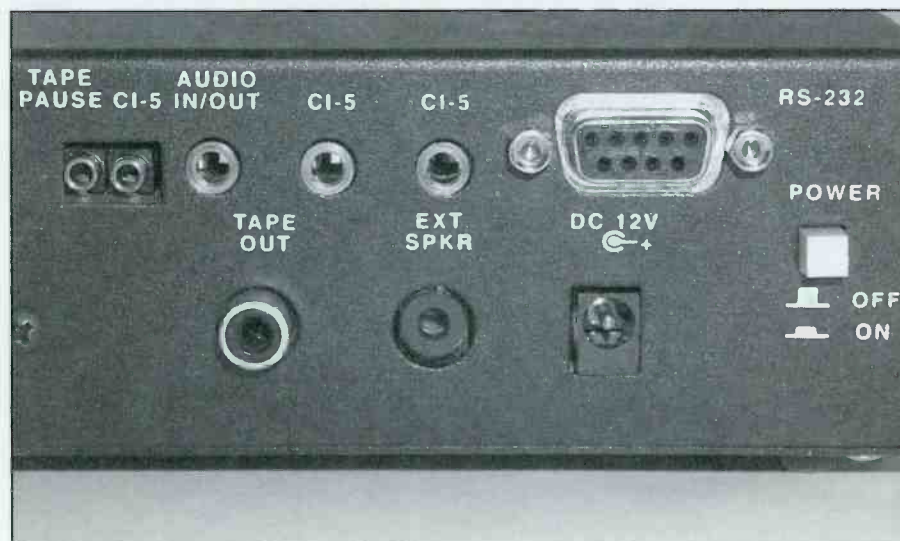

Another "black box" receiver, the popular Optocom receiver has an interface built-in, but also supports the CI-5 protocol for older software and multi receiver configurations.

cations. If you've read this column for a while, you'll know that my favorite computer-controlled system is an Optoscan controlled radio and Datafile's Probe software. Information on Probe is available from directly from Datafile at <datafiles@aol.com>.

OptoCom

Any look at computer-controlled systems would not be complete without a quick mention of the OptoCom scanner. It's essentially a PRO-2042 scanner with an OS-535 interface assembled into a black box. It's got several enhancements over the OS-535, including the ability to support trunking systems with software.

The connection, just like the ICOM PCR-100/1000 and WinRadio systems, is simply a cable from the computer to the radio with a supplied cable. Once connected, most of the software that works with the OS-535 will run the OptoCom, as well as many upgraded or expanded applications that take advantage of the enhanced capabilities of the OptoCom. Currently, programs like ScanStar and TrunkTrac are the only ones offering support for the trunking modes of the Optocom. I have not tried ScanStar's newest version, as it was still in beta at the time of this writing, but TrunkTrac does an excellent job of following up to four Motorola trunked systems. TrunkTrac is featured in this month's "Product Spotlight." We'll have a more detailed review of ScanStar, including its new trunking support, soon.

Uniden BC-895

One of the more pleasant surprises when the TrunkTracker radios first became available was that they too would include a computer interface. The BC-895 has a unique connection on the back, so you'll need a custom cable. It's available from several sources, including Computer Aided Technologies <www.scancat.com>. The interface is built into the radio, so it's pretty straightforward once you get the cable.

Software is a different animal on this receiver. While the interface is there, I'm told by programmers that the protocol really doesn't support computer control of the receiver very well. It does, however, allow for upload and download of the memories, and one other feature that makes computer connections on this radio worthwhile.

The interface will allow a kind of computer assist that we haven't really seen much need for until now. That is, the radio will report when it has found an active ID to the computer interface. Using this information, applications can then look up an alpha numeric tag for this ID number and display that on screen. It's kind of like the computer following the radio instead of controlling it. Most of the major multi-radio software packages (ScanStar, ScanCat, Radio Manager) have a special trunking manager program to run with the BC-895 in trunking mode. Several other dedicated software choices are available as well. You'll have to decide if it's worth the trouble to get alpha tagging and upload/download on this radio or not.

Yaesu FRG-9600

This is an old classic receiver that is quite often credited with starting the computer control movement. If you have one of these, you'll probably be aware that it is a terrible scanner by itself. Ten channels at a time is one of its major limitations, but there are others. It also turns out that it's an excellent communications receiver on its own. Just a lousy scanner.

So, computer-control to the rescue. ScanCat was one of the very early supporters of this receiver, and it saved the usability of the radio. These days, the 9600 is more of a collector novelty than a serious contender in the computer-control market. Probably of interest mostly to those old enough to remember it, but who've never had the challenge . . . er . . . thrill of operating one.

The 9600 requires an interface box, the Yaesu CAT, which is still available, believe it or not. Yaesu uses it for many of their computer-controllable HF receivers and transceivers as well. Once you've got the interface and the radio, a couple of cables will get you connected. Just make sure that you get software that still supports this old timer.

So Get Connected!

Well, there you have it. I realize that I haven't covered every radio that has a computer interface, but most of them have been included. If I didn't include your radio, it's probably a very close variation of one of these. And at the price of used and refurbished computer systems, there's no excuse not to get your equipment up and running to take advantage of all that computer assistance or control has to offer. You'll be glad you did!

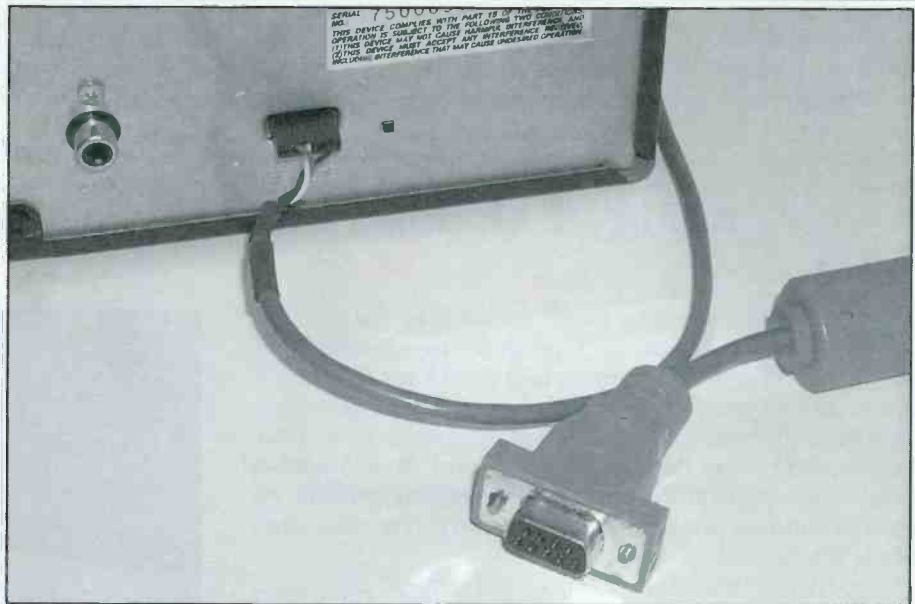

The Uniden BC-895 requires a special cable but connects right into your computer. There is software for upload and download of frequency information, as well as providing alphanumeric information for scanned IDs as they are tracked.

Software is changing all the time. Search the Internet, ask friends, and check out demos as much as you can. Many good programs are available as shareware or even freeware, so don't overlook them. We've been working on several major applications and have reviews coming up here in "ScanTech" and in our "Product Spotlight" section as well, so don't overlook that option for further information. One of the neat things about computer-control is that the software is relatively inexpensive, and by simply changing software, you can make a tremendous difference in the

capabilities and features of your computer controlled setup. Have fun!

Your Input Needed

Got a solution to a computer-control problem that I missed? Got a question on a specific radio? Send it in. If I don't know, we'll ask the readers to help out. You'd be amazed at what a great resource you all are. I'm just the middleman. Don't forget an SASE if you need a direct reply. Ken Reiss, 9051 Watson Rd. #309, St. Louis, MO 63126 or E-mail at <armadillo1@aol.com>. Until next month, Good listening! ■

SEE US ON THE WEB!
www.vikingint.com

Rave Review
Pop Comm
April '96

Professional 10 HOUR RECORDER

"BUILT LIKE A BATTLESHIP"

SPECIAL
Pop Comm
Price..

\$159

- Heavy duty commercial recorder - NOT improvised from consumer models
- 12, 14, and 16 hour models also available
- BUILT-IN voice activation (add \$30)
- Applications information included
- Dimensions: 11.5 x 7.0 x 2.75"

FREE
REPAIR KIT
AVAILABLE

CODs OK. Calif. residents add tax. Sorry, no credit cards. Free catalog USA only, other countries \$.

Free Shipping to 48 Contiguous States on Prepaid Orders

Viking Systems International

Factory Direct **Phone: (415) 467-1220 • Fax: (415) 467-1221** "Since 1971"

100 North Hill Drive #42, Brisbane, CA 94005

CIRCLE 73 ON READER SERVICE CARD

the ham column

Getting Started As A Radio Amateur

Hamfests: Goodies Galore — And Real Live Hams!

Assuming civilization hasn't collapsed by the time this issue reaches your back porch (or the smoking Y2K crater that used to be your ham shack), it's time to celebrate the new year by buying some ham gear at bargain-basement prices. Where, you might ask? Magazine classifieds? No. The Internet? Nope. Both are too impersonal. To add warmth to the winter and to properly celebrate the new millennium, we need face-to-face bargaining and camaraderie. The place to do that is at a hamfest, of course!

If you haven't attended one in person, a hamfest, also known as a giant flea market or swapmeet, is quite an event. Take a trade show, a family reunion, a factory outlet mall, a multi-family garage sale, and spring break at Daytona Beach, add a liberal dose of ham radio and computers, and you've got a modern hamfest.

Large multi-day hamfests, such as the annual Dayton HamVention, or the many ARRL Division Conventions, attract thousands of hobbyists. Regional and local hamfests may draw only a hundred. At Dayton, you'll find more than a dozen specialized forums; at a small hamfest in northern Idaho, you probably won't find any. You will have plenty of fun, however, at both extremes.

Nearly every hamfest has a swapfest or flea market where individuals and commercial dealers hawk their wares. Generally, flea markets on both coasts will have more exotic hardware, such as microwave assemblies and transistors, but prices overall will tend to be higher. Smaller Midwestern hamfests may not offer as much high-tech stuff, but you'll usually find a surplus of good, used HF gear. A transceiver that will fetch \$700 in New England will probably sell for \$500 in Iowa.

Many hamfests and flea markets, much to the chagrin of some, are piled high with computer stuff, from obsolete parts to new systems. Don't bother getting upset. Computers and ham radio are forever merged. Why not take a look at everything?

A Calendar Of Events

Information on upcoming hamfests is available from several sources. If your local ham buddies don't know what's up in your region, check out the list of hamfests and ARRL-sponsored conventions in *QST* or at www.arrl.org. Hamfests tend to be annual events, so once you've identified a few in your area, you'll probably be able to go back year after year.

Purchase Like A Pro

Because we think of hams as friends, it's difficult to think that we could never run into a bum deal at a hamfest. After all, these people are fellow hams! Although most individuals and commercial outlets selling hamfest gear are on the level, smart shopping and healthy dose of preventive caution will help you



Although I've been a ham for more than 20 years, these Cherokee FR-460 FRS rigs are the first handheld radios I've ever owned. As you can see, they're small! Check them out at www.wirelessmarketing.com. For more info on FRS in general, point your browser to www.fcc.gov/wtb/prsfamrad.html.

avoid unwelcome surprises. Here are a few tips for buying used radio or computer gear at hamfests.

- Start early and stay late. The best hamfest deals are usually made in the first and last hours of each event. Getting to the hamfest early will allow you to snap up some of the best merchandise. If you wait too long, your favorite stuff will be gone. Alternately, if you play the waiting game, sellers will be quick to discount stuff that did not sell previously.

- Stay within your means. Most of us don't have government-funded budgets for ham radio acquisitions. But going to a hamfest, however, is like going to the candy store. If you're not careful, you'll go home with plenty of "sweets" and no mortgage money. If possible, plan your spending in advance.

- Negotiate. If you equate hamfests with Arabian street markets, you'll do fine. Haggling over the price of used gear or components in a friendly and generally reasonable manner is appropriate and expected. But don't overdo it. "Ham" isn't a synonym for nocturnal key-swiping cheapskate for nothing!

BY KIRK KLEINSCHMIDT, NTØZ

FRS Is Real Radio

If you've been to a big auction or a large amusement park lately, you've probably seen people chatting on tiny digital hand-held radios. Looking like the tiniest 2-meter rigs you've even seen, these FM transceivers operate in the Family Radio Service, FRS for short. These handy, teeny radios put out a half-watt and function on 14 frequencies near 400 MHz. Many FRS radios offer weather-band receivers and security codes that prevent the receiver from "unsquelching" unless the proper code has been received. Some can even be made to work like pagers and ring like telephones! These little buggers have a one- to two-mile range and, because they incorporate advanced circuitry, they sound great. Not bad for a rig that costs \$60 to \$150!

So what's my point? A lot of hams look down their noses at FRS because it "isn't ham radio" and users "don't have to pass a licensing test" to use them. Well, folks, that's all wrong! Radio is radio. FRS handhelds are functional, incredibly small, and entirely handy. And you can talk to hams and non-hams alike, which may secretly irritate the "licensed radio or bust" crowd.

When I go hunting and fishing with my brother, we each pack an FRS handheld. When the youngest kids go to the park down the street, they can't take a 2-meter ham rig, but they can take a small FRS rig so they can call home during emergencies.

With my yellow Cherokee FR-460s, I get a solid 1.5-mile range in and around town. Across a big lake, I've "DXed" out to five miles or so. Naturally, the FCC doesn't want FRS to be used as a long-distance "communication service;" they want FRS radios to be generic, short-range "walkie-talkies" for the masses.

In my small Midwestern town, I've never heard anyone else using FRS, but in metro areas, FRS chatter is very common. FRS users are starting to have "QSOs!" Hey, that sounds a lot like ham radio! Instead of ignoring FRS, we hams should embrace it as the excellent utilitarian service that it is, and we should embrace FRS users who may want to migrate to amateur radio once they've taken the FRS plunge.

At my next hamfest, I'm leaving my 2-meter rig at home and I'm bringing my nonham girlfriend and a pair of brilliant yellow Cherokee FR-460s. Without the "unlicensed" mini rigs, I couldn't leave my table.

• Plug it in. Always try to test expensive gear. If you're buying a major item, such as a transceiver or receiver, make sure you're able to plug the thing in somewhere to see if it works. As mentioned previously, most sellers represent their merchandise accurately, but it never hurts to power up a potential acquisition.

• Service after the sale? In a similar vein, make sure you get the seller's name, address, and phone number — just in case. Although you probably won't have major problems with a piece of gear you've thoroughly inspected and casually tested, it never hurts to be prepared. If the seller is truly compassionate, you may be able to negotiate a return policy. (When I sell big-ticket items at hamfests or via the Internet, I always offer a five-day return option.)

• If you're uncomfortable buying from individuals, don't forget to check out the commercial vendors (they usually have their

own part of the show floor). Just like their individual counterparts, most vendors are in a wheeling and dealing mood at hamfests — especially during the last hour or two. "Hey, mister, you don't wanna haul that big, heavy transceiver all the way back to your truck, do ya?"

• Talk to the buyers and the sellers — and I mean really talk to them. Hams are usually shy creatures. Say anything to get them talking. If you can't agree to a deal in a conventional manner, offer up a crazy deal. Offer to buy more stuff if the seller will meet your price on that one special item. Trade something of your own. Buy something at another table and trade it to your seller for the things you want. Offer to haul away all of the sellers junk at the end of the show. At one time or another, I've succeeded with all four strategies. Be nice, be creative, and be persistent.

Have Fun!

Hamfests are a wonderful part of amateur radio. They will sustain you through thick and thin. They will open doors to new pursuits. And they will expose you to interesting and handy-to-know friends and fellow hams. If you've never attended, get busy! If you live near a large metropolitan area, you can find at least one nearby hamfest almost every weekend. If you're in a more remote area, you'll have to plan ahead. Whatever it takes, you owe it to yourself to see what it's all about. You'll see me there, pawing through the weird stuff under the tables.

See you next month. Send your QSL cards, questions, and letters to *Popular Communications*, "The Ham Column," 25 Newbridge Rd, Hicksville, NY 11801.

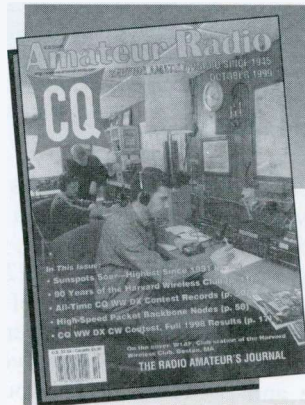

If you enjoy
Amateur Radio,
you'll enjoy CQ.

It's a different kind of ham magazine. Fun to read, interesting from cover to cover, written so you can understand it. That's CQ. Read and enjoyed by over 90,000 people each month in 116 countries around the world. It's more than just a magazine. It's an institution.

CQ also sponsors these fourteen world-famous award programs and contests: The CQ World-Wide DX Phone and CW Contests, the CQ WAZ Award, the CQ World-Wide WPX Phone and CW Contests, the CQ World-Wide VHF Contest, the CQ USA-CA Award, the CQ WPX Award, the CQ World-Wide 160 Meter Phone and CW Contests, the CQ World-Wide RTTY Contest, the CQ 5 Band WAZ Award, the CQ DX Award, and the highly acclaimed CQ DX Hall of Fame.

Accept the challenge. Join the fun. Read CQ.

Also available in the Spanish language edition.

Write for rates and details

SUBSCRIBE TODAY!

	USA	VE/ZE	Foreign Air Post	Visa, Mastercard, American Express, Discover accepted. Please send card number along with expiration date with you name, address, city, state. US dollars only.
1 Year	27.95	40.95	52.95	
2 Years	49.95	75.95	99.95	
3 Years	71.95	110.95	146.95	

Please allow 6-8 weeks for delivery of first issue.

CQ Magazine, 25 Newbridge Road, Hicksville, NY 11801

Ph: 516-681-2922 FAX 516-681-2926

the listening post

What's Happening: International Shortwave Broadcasting Bands

WTJC Picks A Frequency, And A New Dominican Republic Station On The Air . . .

The contestant calls out "9690!" and the pretty lady on the screen removes that panel and reveals a "no." Another calls out "9725!" and Miss Lovely pulls away that panel. Another "No!" The audience groans. The third contestant calls out "9370!" And the word revealed is "Yes!"

9370 — after two earlier choices — is where you'll find the newest U.S. station on your shortwave dial, — more likely, "readout." WTJC started broadcasts in late September from **Newport, North Carolina**. As reported last month, the station is a part of the Fundamental Broadcasting Network (FBN), the flagship of which is WOTJ in Morehead City, North Carolina and is owned by the Grace Missionary Baptist Church. Programming on WTJC, (which stands for Working Till Jesus Comes) will be from WOTJ but will also include religious broadcasts in Russian, Chinese, French, and Spanish. The initial schedule is from 2200 to 1100 and 1200 to 1400.

The transmitter is a reconditioned 50 kW General Electric unit working with a terminated Rhombic antenna with an azimuth of 40 degrees. Eventually, the station plans to operate with 61 kW. The antenna gain will create an effective radiated power of a million watts.

Reception reports are welcome and may be sent to FBN, 520 Roberts Road, Newport, NC 28570. You should address your letter to the attention of David Robinson. You can also E-mail them at: <fbn@clis.com>.

Another new station on the air is **Radio Villa - la Sencilla**, (usually announced as just Radio Villa) in the Dominican Republic, now operating on **4960**, relaying their sister station on 1480 mediumwave. The 60-meter band channel was formerly used by Radio Cima. The station welcomes reception reports to Apartado Correo 804, Santo Domingo, Dominican Republic. They run until just past 0600.

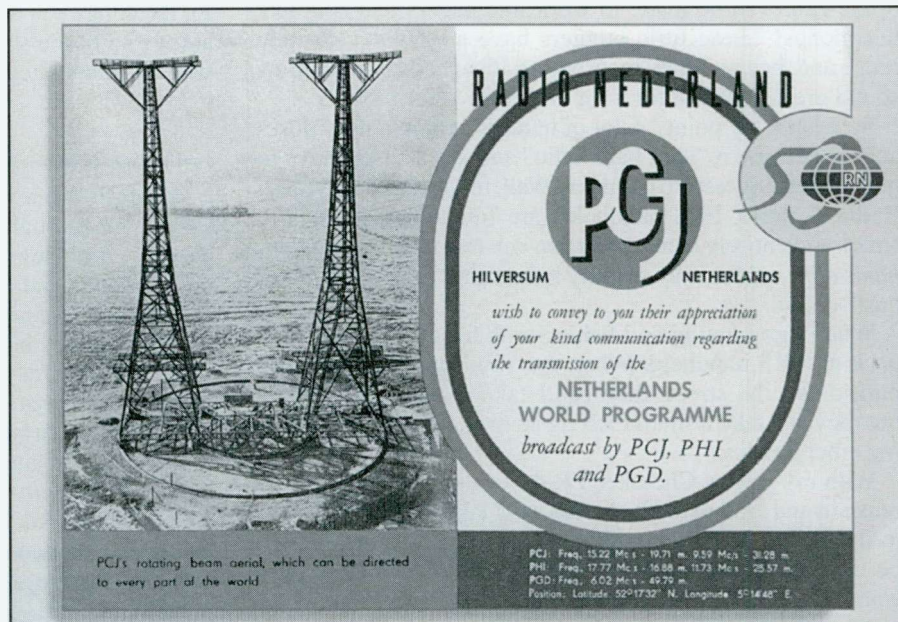

One of the all time classic QSLs — PCJ, Hilversum, the Netherlands — forerunner to today's Radio Netherlands. (Courtesy Dr. Adrian Peterson, Adventist World Radio)

RDP, Portugal is now being relayed via Taiwan, in order to provide better coverage of East Timor, currently airing from 1000 to 1100 and 2200 to 2300 on **11550**. This has the feel of something that probably won't be around long, so if you are into such oddities, you better go for it now.

A reminder about another temporary target: the **Israeli Defense Forces station Galei Zahal**, assumed to be active now because personnel are involved in relief work for Turkish earthquake victims. Check **6898** during our evenings and **12197** during the day. Watch for better signals from **Radio Tanzania's Zanzibar station** which, by now, should be armed with a new 50 kW transmitter. Normally, reception from this station is fair, at best. And best heard up to 2100 closing (often earlier) on **11734**.

In addition to its long-time relay agreement with WYFR, **Radio Taipei International** is now also carried by the Skelton (UK) BBC transmitters operated

by Merlin Communications. The relay is on in English from 1800–1900 on **3955** (fat chance here!), 1900–2000 in German on **6175**, and 2300–0000 in Mandarin on **3975**.

Check **15140** around 1400 or 1430. **Radio Sultanate of Oman** is reported to be airing an English language segment in this slot. Also try 2300–0000 on **9735**. It's possible this is a temporary or perhaps just a sometime thing. They've stuck strictly to Arabic for a long, long time.

For some time now, the status of many of the provincial stations in **Papua New Guinea** can only be termed as shaky, with many of them off the air or on reduced schedules or operating at less than their usual power (never high to begin with). But at least one of the silent ones — **Radio Simbu in Kundiawa** — has come back and, apparently, so have (or will) all of the stations which were off the air due to funding cutbacks and disagreements over which government entity really had

BY GERRY L. DEXTER

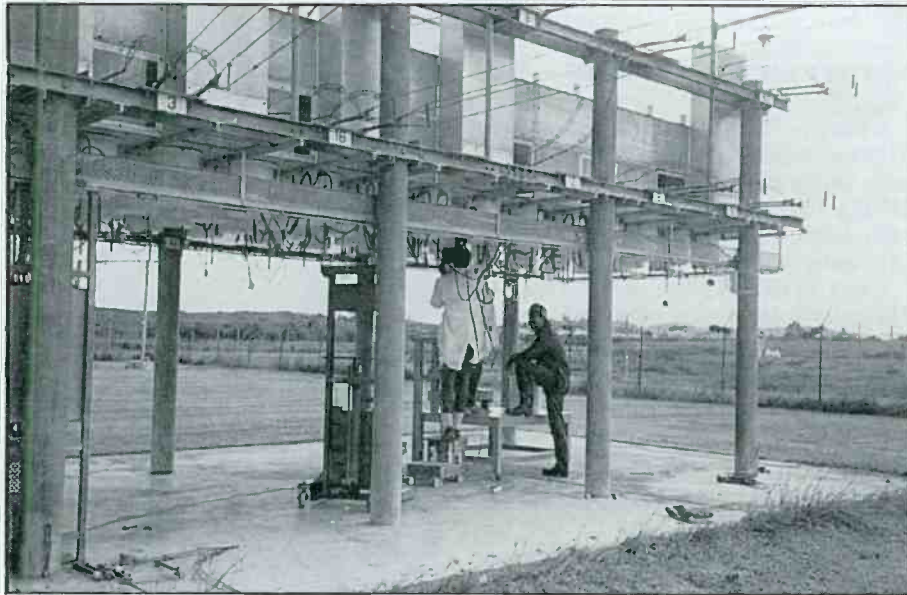

Part of the transmitting installation at the Antigua relay of DW and the BBC. (Thanks Steven Forest, OH)

overall authority. **Radio Simbu** operates with 10 kW on **3355** and is best heard (when it's heard at all in North America) around local sunrise.

We still don't know the fate of **Radio Minurca** — the United Nations-funded station in the Central African Republic. Its mission will have officially concluded about the time you read this, but station officials are hoping they can get their mandate extended. Try their one-kilowatt transmitter on **9900**, scheduled from 1600 to 0600.

It's probably a very temporary situation but **Radio New Zealand International**

says there are some serious technical problems with their transmitting facility and thus they are forced to use only 17675 for their entire schedule. Hopefully, things will be cleared up quickly enough to make this entire paragraph unnecessary!

This month's book winner is regular reporter Tricia Ziegner of Waterford, Massachusetts. Tricia is always chasing — and frequently hearing — places such as Mongolia and many of the former Soviet Union republics. As a thank-you for her steady reports to this column, we're arranging for Tricia to receive a



This oversized card from Radio Australia shows boats at anchor in the harbor at Strahan, Tasmania.

copy of the year 2000 edition of *Passport to World Band Radio* (which no SWL or DXer should be without). Thanks to Universal Radio for their cooperation. If you don't have Universal's astounding catalog of radio stuff for every interest, call or write for one. (800)-431-3939, E-mail: dx@universal-radio.com or write them at 6830 Americana Parkway, Reynoldsburg, OH 43068

Remember your reception logs are always very welcome. Just be sure to list your catches by country, double-space (at a minimum) between each one, and add your last name and state abbreviation after each item. Other things we appreciate having your help with are spare QSL cards you don't need returned, station photos, brochures, and other materials, including schedules. And, hey! How about a photograph of you at your listening post? We'll be glad to do our bit to help make you a DX star! As always, thanks so much for your continued interest, support, and cooperation! We appreciate it very much indeed!

Here are this month's logs. All times are in UTC, which is five hours ahead of EST, i.e. 0000 UTC equals 7 p.m. EST, 6 p.m. CST, 5 p.m. MST, and 4 p.m. PST. Double capital letters are language abbreviations (FF = French, AA = Arabic, SS = Spanish, etc.). If no language abbreviation is included, the broadcast is assumed to have been in English.

ANGUILLA — Caribbean Beacon, **6090** at 0300. Gene Scot and same old, same old. (Newbury, NE)

ANTIGUA — BBC, **5975** to Europe and the Americas at 0157 with "Meridian Feature" followed by "The World Today." Also at 2300 with news. (Jeffery, NY) **17840** at 1500 with news. (Newbury, NE)

AUSTRALIA — Radio Australia, **9440** (Brandon site) at 1426 with discussion on laws. On **11880**, also Brandon, at 0430 in CC. (Miller, WA) **9580** at 1424 with Latin-influenced jazz. (Newbury, NE) 1213 in EE with rap. Also **17795** at 0149 with interview. (Jeffery, NY)

BELGIUM — Radio Vlaanderen, **15565** (via Bonaire, Netherlands Antilles) at 2231 with "Radio World." (Jeffery, NY) 0400 with DX news. (Newbury, NE) 0400 with tourism program and featured CD. (Hill, ID)

BULGARIA — Radio Bulgaria, **9400** at 0153. Woman announcer and violin music. (Wilden, IN) 0234 with modern Bulgarian music. (Newbury, NE)

CANADA — CFCX, Montreal, **6005** at 0413 with EE news, discussion. (Miller, WA) Radio Canada Int'l, **9755** at 0245 with music composed especially for shortwave. (Newbury, NE) **11865** at 0458, co-channel interference from Deutsche Welle in GG. (Miller, WA) **13650** at 2030 with ID, fre-

Abbreviations Used in Listening Post

AA	Arabic
BC	Broadcasting
CC	Chinese
EE	English
FF	French
GG	German
ID	Identification
IS	Interval Signal
JJ	Japanese
mx	Music
NA	North America
nx	News
OM	Male
pgm	Program
PP	Portuguese
RR	Russian
rx	Religion/ious
SA	South America/n
SS	Spanish
UTC	Coordinated Universal Time (ex-GMT)
v	Frequency varies
w/	With
WX	Weather
YL	Female
//	Parallel Frequencies

quency info, news, weather, "Maple Leaf Mailbag." 17765 at 1336 with "This Morning," parallel to 13650. (Jeffery, NY) 15325 at 2155 with news in FF. (Wilden, IN) BBC via Sackville, 9515 at 1300 with "News Hour." (Jeffery, NY)

CHILE — Voz Cristiana, 17680 at 2244 in SS with music, ID. (Jeffery, NY)

CHINA — China Radio Int'l, 7405 monitored at 1430 with business news.



Part of the Radio Canada transmitting facility at Sackville, NB, which also relays programming from several other international broadcasters.

(Newbury, NE) 11675 at 1225 with ID, news. (Northrup, MO)

COSTA RICA — RFPI, 15050 at 0215. (Newbury, NE)

CUBA — Radio Havana Cuba, 9820 at 0315 with commentary: Cuba doubts U.S. acts with humanitarian aims. (Newbury, NE) 11705 at 1200 with ID, news in SS. (Northrup, MO) 12000 at 0250. Harmonic of 6000. (Alexander, PA)

CZECH REPUBLIC — Radio Prague, 7345 at 0310. Many bank robberies in Prague, criminals come from former U.S.S.R. (Newbury, NE) 15545 at 2248. Feature on Franz Kafka, IS, ID, off at 2258. (Jeffery, NY)

ECUADOR — Radio Quito, 4919 at 0408 in SS with music. (Miller, WA) HCJB, 17760 at 1930 with "Ham Radio Today." Also 17795 at 2138 in SS with music, talk by woman. (Jeffery, NY)

EGYPT — Radio Cairo, 9475 at 0315 with Egyptian music. Poor modulation. 12050 at 0312 with Koran recitations. (Newbury, NE) 15220 at 1717 in AA. (Miller, WA)

ENGLAND — BBC, 6195 at 1313 with discussion of events in Kosovo. (Miller, WA) 15225 at 1830 in RR. Throat singers from Republic of Tuva (CIS). (Ziegner, MA) 15400 to Africa at 2010. (Jeffery, NY)

FINLAND — YLE Radio Finland, 11755 at 0503 with news. (Miller, WA) 15400 at 1250 in Finnish with pancake recipe as part of learning Finnish segment. (Newbury, NE)

FRANCE — Radio France Int'l, 11670 heard at 1245 with man and woman in FF. (Northrup, MO)

FRENCH GUIANA — Radio France Int'l relay, 17620 monitored at 2300 in SS with IS, ID, news, and news magazine. (Jeffery, NY)

GABON — Radio France Int'l relay, 17560 at 1437 with man and woman talking about a magazine. (Newbury, NE)

GERMANY — Deutsche Welle, 9535 (via Portugal) at 0340 with ID and talk about health. //11810, 13780, and 15105. (Newbury, NE) 15110 at 2354 with chamber music, then gypsy/polka music. Into SS at 0002. 15275 at 0145 in GG. (Wilden, IN)

GREECE — Voice of Greece, 9420 monitored at 0225 in Greek with Greek music. (Miller, WA) 17705 at 1805 with news, travel feature, music. (Jeffery, NY) 2000 in Greek with continuous Greek music. (Newbury, NE)

GUATEMALA — Radio Coatan, San Sebastian, 4780 at 1126 with music in SS. (Miller, WA)

INDIA — All India Radio, 11620 at 1340 with news read by man and woman. //13710. (Newbury, NE) 1826 with music, news. (Ziegner, MA) 15075 (Bangalore) at 0330 in unidentified language. Fade out at 0348. (Brossell, WI) 15140 (Bangalore) at 1714. QRM from HCJB. (Miller, WA)

IRAQ — Radio Iraq Int'l, 11787.4. Opens at 1839 in AA with music and talk. Weak, but clear. (Ziegner, MA)

ITALY — RAI, 11800 at 0013 in II with classical music. Parallel 9675. (Newbury, NE) 15240 at 0110 in II, song, bird chirp IS



Get serious! A painting by Modigliani on a QSL from RAI. (Thanks J. Rampulla, FL)

from 0125 to 0130, hymn, and announcements. (Wilden, IN) 0305 with ID and frequencies in II and SS. (Newbury, NE) 15280 at 0336 in II. (Brossell, WI)

JAPAN — Radio Tampa, 6055 at 0940 in JJ with phone calls. (Newbury, NE) Radio Japan, 9505 at 1432 with Asian music. (Miller, WA) 11705 (via Canada) at 0017 and 0125. Also 17825 at 0326 with music around the world. (Newbury, NE)

KUWAIT — Radio Kuwait, 11990 at 1945 with rap and rock. (Ziegner, MA) 15110 at 1712 with news in AA. (Miller, WA) 15505 at 1210 in AA with AA pops. (Newbury, NE)

LIBYA — Voice of Africa, 15415 English service at 2329 with news, ID. Into unidentified language at 2333. (Alexander, PA) 15435 Radio Jamahiriya at 1702 in AA with news, prayers. //15235. (Miller, WA)

LITHUANIA — Radio Vilnius, 9855 (via Germany) at 0130 with feature on schools in Lithuania. (Newbury, NE)

MEXICO — Radio Educacion, 6185 at 0419 in SS with Latin music. (Miller, WA) Radio Mexico Int'l, 9705 at 0234 with news. (Miller, WA)

MOLDOVA — Radio Moldova Int'l, 7520 at 0300 and 0400 with EE program including news, commentary, and local music. Usually poor and distorted audio. Thought they were Monday-Friday only, but this heard on a UTC Sunday. (Alexander, PA)

MONGOLIA — Voice of Mongolia, 12015 monitored at 1111 in Mongolian. (Ziegner, MA)

MOROCCO — RTV Marocaine, 15345 in AA at 1950 with music and mentions of Rabat. (Brossell, WI) 2105 in AA. (Jeffery, NY)

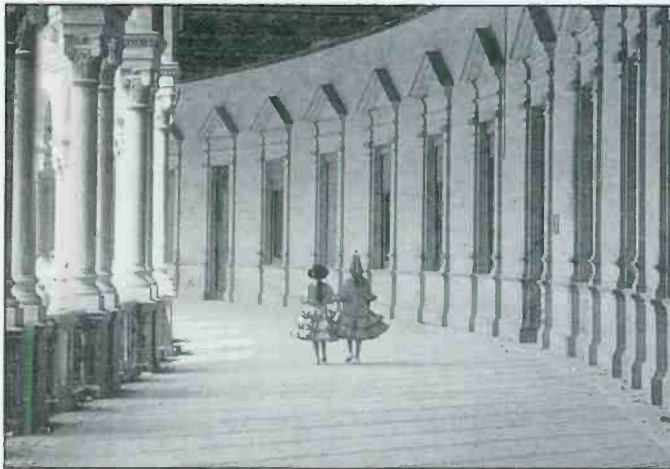

This card from REE, Spain, shows the Plaza de Espana in Seville. (Thanks Andy Johns, TX)

Voice of America relay, **15445** at 2132 with news, "Issues in the News." (Jeffery, NY)

NETHERLANDS ANTILLES — Radio Netherlands, 6165 via Bonaire, in SS at 0417. (Miller, WA)

NEW ZEALAND — Radio New Zealand, **6100** at 1406 with drama. (Miller, WA) **9700** at 0920 with live sports. (Newbury, NE) **17675** at 0100 with news, weather, "Cadenza," (Jeffery, NY)

NORTH KOREA — Radio Pyongyang, **11845** at 0108 with news by woman. (Newbury, NE)

PERU — Radio Union, Lima, **6115** at 0415 with talk show in SS. (Miller, WA) Radio Atlantida, Iquitos, **4790** in SS at 0431 with music. (Miller, WA)

PHILIPPINES — Voice of America relay, **9760** monitored at 1222 with news. (Jeffery, NY)

PUERTO RICO — AFRTS, **6458.5** sideband at 0147 with live sports. (Jeffery, NY)

ROMANIA — Radio Romania Int'l, **15270** at 1721 with "recent history of Romania." (Miller, WA)

RUSSIA — Voice of Russia, **7125** at 0315. (Newbury, NE) **15400** at 0400 with jazz. Also on **15455** and **15465**. (Hill, ID) **15485** at 1953 in FF; into EE at 2000. (Brossell, WI)

RWANDA — Deutsche Welle relay, **17860** at 1853 in GG with classical music, talk by woman. (Jeffery, NY)

SINGAPORE — Radio Singapore Int'l, **6150** at 1412 with EE pops. (Miller, WA) BBC relay, **11740** at 1455 in VV and, briefly, EE. (Newbury, NE)

SOLOMON ISLANDS — Solomon Islands Broadcasting Corp., **5020** at 1159 with announcement, national anthem, and sign-off. (Miller, WA)

SOUTH AFRICA — Channel Africa, **11750** at 0505 with African news, sports, and into Afrikaans language. (Miller, WA) BBC via Meyerton, **15420** at 0340 with news and call-in show to 0400 close. (Brossell, WI)

SPAIN — Radio Exterior de Espana, **15385** monitored at 0022 and 0115 with news items. (Newbury, NE) China Radio Int'l relay, **9690** heard at 0320 with news about increased Chinese investments abroad. (Newbury, NE)

SRI LANKA — Sri Lanka Broadcasting Corp., **15425** at 0145 with listener's requests and U.S. pops. 0200 "You are listening to the Sri Lanka Broadcasting Service." (Brossell, WI)

SWAZILAND — Trans World Radio, **4775** at 0406 in GG with religious music. (Miller, WA)

SWEDEN — Radio Sweden, **9495** at 0255 with special on U.S. pops in Sweden. (Newbury, NE)

SWITZERLAND — Swiss Radio Int'l, **9575**, via Singapore, heard at 1435 with music, news. (Miller, WA) **11660** at 1220 in GG. (Northrup, MO)

TAIWAN — Radio Taipei Int'l, **5950** via WYFR at 0330 with item on liposuction fraud. (Newbury, NE) **17750** via WYFR at 1850 in CC. (Jeffery, NY)

TURKEY — Voice of Turkey, **11655** at 0330 with ID, and thanking foreign rescue teams. (Newbury, NE)

UNITED ARAB EMIRATES — UAE Radio, Abu Dhabi, **15265** at 1719 in AA with news, music. (Miller, WA) UAE Radio, Dubai, **12005** at 0350 with AA talks and singing. Also **15395** at 1945 in AA. (Brossell, WI)

UNITED STATES — AFRTS, **12689.5** upper sideband at 0144 with sports coverage. (Jeffery, NY) KJES, New Mexico, **11715** with usual kids reciting Bible verses. EE/SS IDs at 1501. (Wilden, IN) WRMI, Florida, **7465** at 0330 to 0500 close. Uses **9955** up to 0330. No jamming on 7465 yet. (Alexander, PA)

VENEZUELA — Radio Amazonas, **4939.5** at 0155 in SS with announcements, IDs, Latin music. (Alexander, PA)

YUGOSLAVIA — Radio Yugoslavia, **9580** at 0006 with news, ID, anti-KLA editorial, business feature, travel feature, music, time/frequency info. (Jeffery, NY) 0430 with news, comment, ID. // **11850**. (Alexander, PA) **11850** at 0453 with music, sign-off. (Miller, WA)

That's it for this time. Bring on the power trumpet of Maynard Ferguson to sound a soaring salute to the following who walked the walk this month: Brian Alexander, Mechanicsburg, Pennsylvania; Dave Jeffery, Niagara Falls, New York; Tim Hill, Mountain Home, Idaho; Sue Wilden, Nobelsville, Indiana; Ed Newbury, Kimball, Nebraska; Tricia Ziegner, Waterford, Massachusetts; Mark Northrup, Gladstone, Missouri; Robert Brossell, Pewaukee, Wisconsin, and Mike Miller, Issaquah, Washington. Thanks to each one of you.

Until next month, good listening!

LISTEN TO THE WORLD ON YOUR PC

Worldwide listening is only a mouse click away with **PC RADIO**. Catch world and local news from many viewpoints plus culture, politics, and music. Hear hams, military, commercial airlines, and CB.

Tuning 100 kHz to 30 MHz, **PC RADIO** is a stand-alone, black box connecting to your serial port. Runs on Windows 3.1® or 95/98® and uses 1 MB of hard drive space. Revolutionary "DSP" design provides features only dreamed of in previous receivers in this price class. Even the most experienced enthusiasts will marvel at the performance. **\$295***

- No-Risk 30-day Money-Back Guarantee**
- VISA, Mastercard, and Discover
- **Plus shipping and handling
- **Customer pays shipping both ways.

Download the actual **PC RADIO** software at www.tentec.com

800-833-7373 to order or request literature.

TEN-TEC

1185 Dolly Parton Parkway
Sevierville, TN 37862
Office: (423) 453-7172
FAX: (423) 428-4483
e-mail: sales@tentec.com
Repair Dept.: (423) 428-0364 (8a - 4p EST)

MADE IN TENNESSEE

washington beat

FCC Actions Affecting Communications

Telecommunications In The New Millennium

So what lies ahead on the road to the brave new world? Once we get past the hubbub of the dreaded Y2K turnover and life returns to something resembling normal, we can truly look at the future, beyond January 1st. Congress will return to session after their hiatus for the holidays, still mired about two-thirds of the way into the present session.

As we go to press, various telecommunications issues remain unresolved in various committees. One such item we told you about previously in *Pop'Comm* (May 1999) is **H.R. 514**, the latest assault on scanners. Since that bill benefits *no one*, especially in terms of profit dollars, it has become more of a political "cold potato" while facing an election year of traditional malicious mudslinging. Still, anything could happen. We will all have to wait and watch.

In the last 10 years, we have seen the FCC evolve from a monolithic behemoth issuing virtually incontestable edicts. By the mid-1990's, the agency did become a bit more customer-friendly under former Chairman Reed Hundt. Before those of our readers who work in the telecommunications industry start howling, I will acknowledge that the Commission still had a long way to go. An enormous backlog of license applications yet remained, as well as any number of rulemaking dockets. Today, the FCC truly stands at a critical juncture. There are several paths the agency could follow in the new century. The Commission could become a proactive leader in facilitating communications services. Or it may degenerate into a toothless paper tiger incapable of rendering meaningful services and decisions.

To be certain, present FCC Chairman William E. Kennard speaks of the "digital future" where "innovation is fostered." Try to tell that to those who value the reliability of traditional analog radio modes and systems. Does "digital future" mean that the FCC will push digital technology to the exclusion of all else? Hardly, if we can look beyond Mr. Kennard's necessarily limited view.

Innovation fostered? How do emerging commercial sideband voice transmission technologies fit into a "digital" future? Kennard also speaks of the "New Economy" and a competitive marketplace, as if all needs for communications were commercially oriented, as with cellular phones. Try to sell that concept to police, emergency responders, hams as well as other radio hobbyists, GMRS users, motorists with CB, and Family Radio Service users on a camping trip.

In recent press releases, the Chairman speaks often of "convergence," the politically correct term to describe the use of broadband technology, such as spread spectrum or wide bandwidth channels, to simultaneously carry various modes such as voice, text, images, video, HTML files, etc. We, involved in communications, need to be aware of this coming mode convergence. It is likely to become very popular in the near future, since prevailing digital technologies coming to market facilitate multi-media signals. In an August 12 press release "Chairman Kennard Delivers to Congress Draft Strategic Plan for 21st Century," the FCC gives Congress and the public the clear impression that "convergence" will be a universally accepted concept, embraced by all. From their wording, one would be tempted to think that single mode communications, voice for example, would be gone. Kennard's rambling report could be the subject of much speculation, and would require a series of articles just to analyze it. Rather than peering into a crystal ball and hazarding a plethora of prognostications, it may be wiser to simply watch and see not what might evolve, but that which has allude evolved and that which is *actually* evolving.

The FCC Revises Rules For Wireless "E-911" Caller Location Implementation

Automatic Location Information (ALI) for wireless phones calling 911 was

first mandated in CC Docket 94-102. Originally, this "enhanced" 911 service was to have been implemented by Commercial Mobile Radio Services carriers by October 1, 2001, subject to local Public Safety Answering Point (PSAP) request. In reality, little action has been taken by the wireless telephone industry to implement ALI, other than experimentation of various technological solutions. In the interim, and in keeping with the FCC's spirit of industry competition rather than a cohesive standard, the Commission has amended its rules to give carriers two specific choices in how to achieve ALI service. The revised rules are contained in **FCC Docket 99-245**, the text of which has not been released at press time.

The original ALI concept was network-based. This means that a given wireless telephone network would build in the necessary functionality to track a 911 caller's location. Obviously, this would require a major investment on the part of the carriers. The language of CC-94-102 was not clear about who should pay for this upgrade. Carriers would like to have been compensated for this expense, possibly from the local PSAP agencies, through tax revenue. This point of contention alone is a significant factor in the virtually non-existent wireless ALI services available today. With the new "enhanced" 911 wireless implementation rules announced on September 15, carriers *not* subscribers, now have the choice of configuring their system not for network-based location tracking, but for "handset-based" solutions instead. This essentially refers to Global Positioning System (GPS) functionality built into each mobile phone. Further, the FCC states that any handset-based ALI technology must conform to an as-yet-unspecified compatibility standard. Carriers choosing this method must see to it that these "enhanced" mobile (and portable) phones become available to subscribers by March 1, 2001. By October 1, 2001, 50 percent of all *new*

BY ALAN DIXON, N3HOE <n3hoe@juno.com>

phones activated by the carrier must be ALI-capable, then 95 percent exactly one year after that. However, if the local PSAP requests ALI service activation in their area, then all new phones activated must be ALI-capable within six months of the request, or by October 1, 2001, whichever occurs later.

Anyone experienced with GPS use knows that it doesn't work indoors, under heavy foliage, or sometimes even on the streets of dense urban concrete canyons. Ham APRS users are familiar with the limitations of GPS in parking garages and tunnels. GPS location alone will do nothing to help the individual who carries his cellular phone "powered-off" to conserve batteries and airtime expense of incoming calls, enters any sizeable building, then attempts to call 911 for an emergency. Many people do exactly that, carrying portable phones turned off, often relying on pagers to be alerted of incoming messages. Roamers from systems using network-based ALI technology will similarly be geographically out of luck when visiting a GPS-based 911 ALI system. If you just paid good money for a state-of-the-art digital phone with all the accessories and your carrier chooses

to use GPS-based 911 location technology, how will you feel about your phone being obsolete in little more than a year? In any event, all affected carriers must make their declaration as to which ALI solution they will use, by October 1st of this year.

Reality Is Stranger Than . . . Well, Reality!

Here is just one recap of an item many missed in 1999. On March 23, the town of Brooklyn, Ohio, enacted a city ordinance (1999-27, §331.45) outlawing the handheld use of mobile phones while driving. According to a press release graciously provided by Pam Krickler of Mayor John M. Coyne's office, Brooklyn, Ohio, is the first city to regulate mobile telephone use in the United States. The ordinance does allow hands-free mobile telephone calling, and of course, a handset may be used when a vehicle is stopped. Calls to "public safety forces" are not regulated by the ordinance. Surprisingly, no exception is made for police or other public safety use of handheld mobile phones while driving. The maximum penalty is a \$100 fine.

Regrettably, this action sets a dangerous precedent. In the absence of national standards, a rag-tag patchwork of localities may produce similar regulations, leaving motorists constantly wondering at what points, and under what circumstances, they may or may not place or receive a call.

According to various media sources, enforcement of the new ordinance began in earnest in September. This ordinance, unfortunately, has a vague definition of what constitutes a "mobile telephone." The definition reads: "including but not limited to cellular, analog, wireless, and digital telephones." Huh? The question of applicability to push-to-talk radiotelephone interconnection services, such as commercial trunked radio or amateur radio autopatch, is unaddressed, one way or the other, by the ordinance. Also unknown because it is outside the scope of research for this column, is whether Brooklyn has outlawed other driver distractions. These might include reading while driving, applying makeup, or smoking, which is hazardous while driving in more ways than one. And for some, another dangerous driving distraction may be riding with one's mother-in-law.

Happy New Year! ■

GET ON THE **MT EXPRESS**

Monitoring Times is Now On Line!

Now-Receive your subscription to Monitoring Times with no delays due to mailing, no lost or torn copies. Be the first to receive breaking news from the frontier of communications!

For less than the cost of a subscription in the U.S., you can be reading the entire *Monitoring Times* magazine anywhere in the world before U.S. subscribers receive their printed copies! Active utilities loggings, world hotbed frequencies, international broadcasting schedule changes, new product announcements! This is the exact same magazine that has gained a worldwide reputation for reliable radio information that's easy to understand, and products and projects of proven value.

For a mere \$19.95 U.S., **MT Express** gives you *Monitoring Times* magazine

- in PDF format viewable with free software
- delivered by FTP (10 MB file)
- viewable in brilliant color on your computer screen
- easily navigated by clicking on the Table of Contents
- printable using your own computer printer
- searchable to find every mention of a topic or station schedule
- compatible with software to convert text to audio for sight impaired listeners

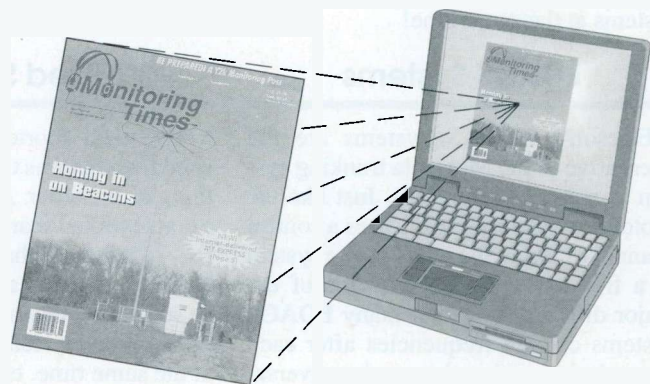

To find out if this new subscription is the delivery solution for you, you may download the August 1999 issue for free! Just go to <http://www.grove-ent.com> to find out how.

One year subscription to **MT Express** - only \$19.95 U.S., or for even greater savings, \$11 in addition to your printed subscription of \$24.95 in the U.S. Mastercard, Visa and DiscoverCard accepted. All payments must be in US funds drawn on a US bank.

ORDER NOW BY CALLING TOLL-FREE (800) 438-8155, OR E-MAIL order@grove-ent.com

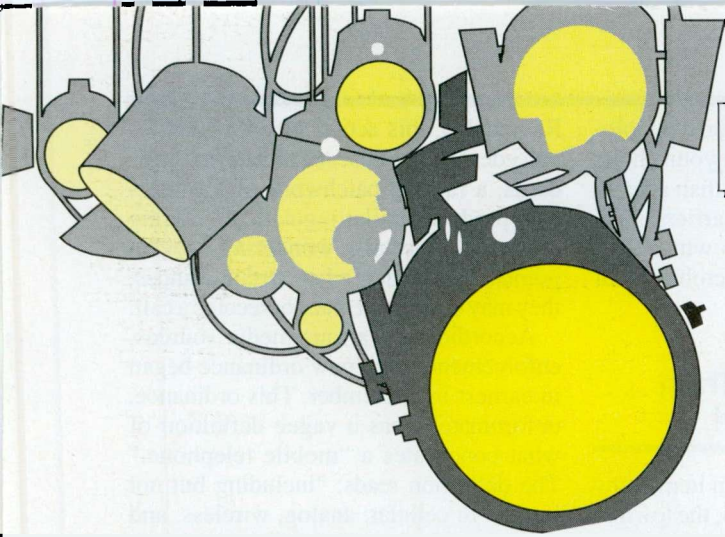

product spotlight

BY KEN REISS
<Armadillo1@aol.com>

POP'COMM REVIEWS PRODUCTS OF INTEREST

Uniden Bearcat BC-245XLT TrunkTracker II

We've been hearing bits and pieces about this receiver for quite some time, but it's finally here. The Uniden BC-245XLT is a replacement for the BC-235XLT TrunkTracker, which introduced the scanning world to trunking in a portable unit. The BC-245 introduces some firsts of its own and will make an excellent addition to your lineup no matter what types of communications systems you scan. Even if you already have a TrunkTracker, you may be interested in this upgrade.

Two notable features of the BC-245 first, and then we'll take a look at the details. The BC-245 is the first consumer scanner capable of following Ericson's EDACS system. It is also the first handheld capable of following multiple trunked systems or trunked and conventional systems at the same time!

EDACS Systems

Ericson's EDACS systems are the alternative to the Motorola trunking system in many communities. Just like the Motorola system, EDACS uses a control channel to direct the users of the system to a frequency as needed. One of the major differences is that many EDACS systems change frequencies after each transmission, rather than each conversation, like the Motorola systems. This makes following any conversation on an EDACS system very difficult with a conventional scanner. The TrunkTracker II changes this problem.

Programming the EDACS system into the TrunkTracker II is very much like programming a Motorola system into a TrunkTracker, with one important difference. In Motorola systems, we had to be concerned about something called a "fleet map." On EDACS systems, we don't have fleet maps, but you do have to be con-

cerned about the ORDER the frequencies are entered into your scanner. This can be a bit more challenging if you can't find information about your local system. Fortunately, most of the EDACS systems I've looked at have the frequencies in frequency order, or grouped by suffix (856.7125, 857.7125, 858.7125, etc., then 856.7175, 857.7175, etc.) Until you get the frequencies in the correct order, you won't be able to correctly follow conversations on the EDACS system.

EDACS systems can also be fully-digital (digital modulation is used to carry the voice transmissions) just like Motorola's Astro system. Currently, no scanner or system available to hobbyists will demodulate these systems, and that includes the TrunkTracker II. You're still out of luck if your system uses digital modulation full time.

Mixed Scanning

The main shortcoming of the earlier trunktrackers was that they had to be one thing or the other. A trunking scanner or a conventional scanner, but not both. The BC-245 breaks that barrier and allows both conventional and trunked systems to be scanned at the same time. In fact, multiple trunked systems can also be scanned at the same time, even if they are different types of systems.

Uniden Corp. calls this "Multi-Track" and it allows you to track up to 10 different systems at a time. You can even store conventional frequencies in the *same bank* as trunked ones and it will alternate between them.

In practice, how well this works depends entirely on how busy the stuff is that you're scanning. The scanner covers the conventional frequencies and then goes into the trunked mode. There is a brief delay while the control channel is



TrunkTracker II, the second generation of trunk-following radio has arrived. Special thanks to the Ham Station in Evansville, Indiana, for providing the sample radio on such short notice!

reacquired. As a trunked system finds an active ID in your scan list, that activity is followed, and then once the delay has expired, the unit jumps to the next trunked bank or conventional system.

You may miss quite a bit of activity while it cycles through if you're listening to busy channels, but if you think about it, you'd have the same problem with a busy bunch of conventional channels in a single radio. Having the flexibility is fantastic. Of course, you can always run the radio on a single trunked bank, just like previous trunktrackers.

Enhancements To Trunking

Even if you only have Motorola systems to contend with, you may still be interested in upgrading to the 245. It offers 10 banks of IDs per trunk group,

or a total of 100, as opposed to the 50 on previous trunktrackers. And, each bank can have a priority ID so that certain IDs in the system take precedence. So, each system has 10 priority channels if all scan ID banks are activated.

Unlike priority operation in conventional scanners, where the audio is interrupted every few seconds while it briefly checks a priority channel, the trunked priorities are only checked during quiet times. But if you have an ID on hold, with the priority active, the system will look not only for traffic on the held ID, but also for activity on any of the 10 priority channels. This could be a major advantage in being able to follow action if your banks are programmed with a little forethought.

Since the Uniden BC-245XLT can handle so many types of trunked systems, the first step in programming a trunked system is to identify the type of system you'll be programming. These include E2 800 (Motorola Type II 800MHz), E2 900 (Motorola Type II 900MHz), E2 Hi (Motorola Type II VHF 137-174 MHz), E2 UHF (Motorola Type II UHF 406-512 MHz) Ed (EDACS), and E1 (Motorola Type I or Hybrid systems 800 MHz). E1 systems will require programming or selecting a built-in fleet map, just like type I and hybrid systems in earlier trunktrackers.

EDACS systems can take advantage of AFS display mode to help find IDs of interest. AFS is Agency-Fleet-Subfleet display and shows EDACS talk groups in this mode. This can be used with the XPAND function to zero in on just the agency or fleet that is of interest while you're researching for ID numbers. It's very convenient for quickly locating pieces of the system that you are interested in monitoring. If, for example, you find that all public safety users are on agency 11, fleet 06, you can enter 11.06 ENTER into the search mode and then only IDs in that particular fleet will be found. Or if you find that the water department uses agency 14, you can lock that entire agency out by entering 14, ENTER, and then L/O. These are very powerful enhancements to the search function for EDACS systems.

Motorola users aren't left out completely. In addition to now being able to track many systems on the 900 and 400 bands, as well as VHF when those systems come on line (I'm not aware of any YET), we have a new search aid also. For mapping type I systems, you can turn the status bit function off. This will help those who are having difficulty figuring out fleet maps on hybrid systems. Once the

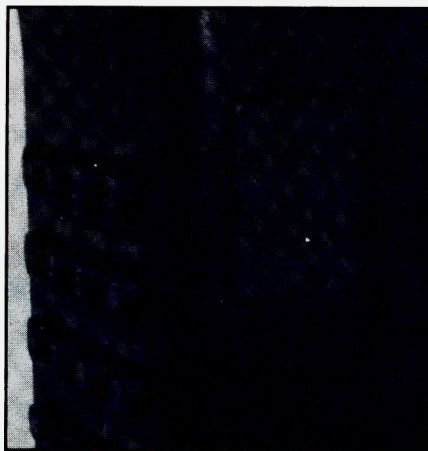

In addition to all the new trunking and conventional features, the BC-245 features a computer connection for remote programming. It can even dial into Uniden's frequency database directly and program itself based on a zip code you enter.

fleet map has been determined, and on all type II systems, you'll want to leave the status bit on so that you'll hear all of the specialized communications associated with a particular talkgroup.

Setup for the VHF and UHF systems require an extra step. On 800 MHz and 900 MHz, there are standard channel plans that are used to designate channels. Unfortunately, since channel assignments were made in the VHF and UHF bands well before trunking was even thought of, there are not standard channel assignments. Instead, a "base" frequency and "Offset" must be found. No doubt this information will be made available shortly on Websites like <www.trunktracker.com>, as systems are discovered and mapped. If you find info on a local system, don't hesitate to send it in to "ScanTech" for inclusion here in *Popular Communications*.

The BC-245 also includes an RF Attenuator of about 15dB. Unfortunately, the attenuator is "on" or "off" across the entire range and all channels of the scanner. It's certainly better than no attenuator at all, but it would be nice to have on switchable per channel. This feature, and the lack of CTCSS/DCS tone squelch for conventional scanning keep the BC-245 from being the ultimate handheld scanner, but it's awfully close. Many users won't miss either feature.

Computer Control

The BC-245XLT also offers a computer interface! Not only can the radio be programmed and controlled by computer, but Uniden has included a special SmartScan

feature. This allow you to connect the radio to a special server through a 900 number using either an external modem directly, or through your PC's modem using a supplied program.

Once you activate the system, you are prompted to enter your zip code, which is stored for later use. The system will then dial into the Uniden server and download up to 300 frequencies for your area. Unfortunately, there is no control over what 300 frequencies you will get, or in what order they might be loaded. The data is based on FCC records of transmitters licensed in your area. While a novel approach, and certainly valuable for getting first-time scanner users up and running, I'm not sure how valuable it will be for experienced scanner listeners. There is a 99 cent per-minute charge for the call, so it's not something you'll want to do often. Unfortunately, the system was not up and running by the time of this review, so I was not able to test it.

The same connector and cable that are used for the SmartScan system, however, can also be used to program the radio from computer control software. Various applications are in the process of being updated to support the BC-245's unique modes and should be available shortly. That's a valuable addition to any radio!

The Bottom Line On The 245

Overall, the BC-245XLT is an excellent scanner, not just a trunktracker. It makes it hard to recommend any other handheld for a beginner, particularly if they are unaware of the types of systems they'll be scanning. Three-hundred channels are more than adequate for a conventional scanner, and the wide variety of trunking systems available will cover a large percentage of the systems that are currently on the air as well as future expansion. Of course, digital systems and digital modulation could throw someone a curve, but fortunately, very few systems nationwide are using these modes full time.

As an experienced scanner listener, you'll definitely want this radio if you live near almost any kind of trunking system. The expansion of IDs from 50 to 100 per system and the ability to scan conventional and trunked at the same time make the BC-245 a valuable upgrade, even if you only have Motorola systems nearby. Not to mention the PC programmability. At a street price of \$225-\$250, it's really quite a good deal. Check it out at a dealer near you!

cb scene

27 MHz Communications Activities

CB Predictions For The New Year And Beyond

Happy New Year! "How dare you," you say, "writing in mid-October (which is when this was written), in light of all the gloom and doom predictions for disasters that will occur on or about January 1, 2000, wish the survivors — should there be any — a Happy New Year?" I do so quite confidently, knowing that at least some of you will be reading this in December. After all, mid-December is when this issue of *Popular Communications* starts arriving in mailboxes and showing up on the newsstands. And, as you read this, if the prophets of doom have been correct, the supply riots have already started. If they have, then the predicted toilet paper shortages alone will have already made this issue an early sell out!

I also do so, albeit a little less confidently, knowing that foretelling the future is a risky business. Nobody really ever knows what is going to happen. If, by chance, life on this planet does cease to exist on the first of the year, then look me up on the other side, and point out my error and we will both have a good laugh. If, however, the doomsayers are wrong, and life continues into the next Millennium, then the worldwide 11-meter community is in for some challenging and exciting times. So, let me don my turban, dim the lights, swoon into trance, and tell you what I see coming in the not-too-distant future. Ooh, it's getting clearer, clearer, yes . . . yes . . . there it is.

I see two mysterious forces bearing down mightily on the world of 11-meters. Each is very large and each is very powerful. One is getting larger and stronger; the other becoming more compact, yet more potent. Both are inscribed with three initials. One says FCC, the other, WWW.

There is battle — no, not a battle — a series of battles. The FCC and WWW seem to be at war for the very heart and soul of 11-meters. One pulls one way, the other in a different direction. Suddenly, 11-meters starts fighting back, a move neither FCC nor WWW seems to have expected, for it takes them totally by surprise. The battles are halted, a truce is called, and a treaty is signed.

GRUPPO RADIO ITALIA
ALFA TANGO
TRI-STATE DX NET

FRIENDSHIP THROUGH RADIO

**SPECIAL QSL
1ST TIME CHECK-INS**

Alfa Tango's special QSL.

As a result of the treaty, changes come to 11-meters. It is given more range, space, power, and responsibility. It also gets more access to and better use of WWWW, as well as more help and attention from FCC. FCC gets to shed excess baggage and gains more respect and cooperation from 11-meters. WWWW gets to

share 11-meters' abundant population of experienced communicators. Together, they march into the new Millennium with a common goal and purpose: better communications for all.

Far fetched? No, not really. I am not saying that we will see it all happen this year, or in five years or even in 10. All I

GRUPPO RADIO ITALIA
ALFA TANGO
INTERNATIONAL DX GROUP
Division: USA

2 AT 101
Op. JIM
P.O. Box 155 New York City, NY
10471-0155 USA
Super Class Operator

NEW YORK

Calling all over the world

A card from AT's "Super Class Operator," Jim.

BY ED BARNAT <Edbarnat@global2000.net>

am saying is that it *could* happen. In fact, some of it is already taking place.

We are beginning a whole new century. It is a century full of promises, challenges, and opportunities. As we enter it, there are two forces already at work that will greatly influence life on 11-meters over the next few years. They are the FCC and the Internet. Both could be potentially devastating and either could prove extremely helpful to us as we pursue our hobby. It all depends on how we play them.

A New FCC For The 21st Century

The most immediate challenge to life on 11-meters is the FCC. Even as you read this, a "New FCC" is being formed. Commission Chairman William F. Kennard describes the new agency as "flat, fast, and functional." The two most interesting aspects of this reorganization for us will be the Commission's desire to reduce the number of regulations they have to enforce and to do a better job of enforcing the rest by combining its fragmented enforcement efforts into a single new Enforcement Bureau. Will the new Enforcement Bureau produce more enforcement actions against CBers and Freebanders? It could, at least that is the impression *Pop'Comm* editor Harold Ort (see article in next month's *Pop'Comm*) got during a recent interview with FCC's Riley Hollingsworth.

"CBers, beware," says Ort, "Uncle is on the prowl big time, and gunning for you if you're operating high power and out-of-band. I'd say that this renewed interest in shutting down operators doing the illegal thing will be around for a long, long time."

To find out if that were true, I spoke to Hollingsworth. He will be with the new Enforcement Bureau and he will have a



4091 Viscount Avenue
Memphis, TN 38118
(901) 794-9494
Fax: (901) 366-5736
Visit our Website:
www.majestic-comm.com/maco

ANTENNAS • POWER SUPPLIES • CABLE ASSEMBLIES
HIGH PERFORMANCE and MADE IN U.S.A.



MACO 2400

Wattmeter 20-200-2000-4000 watt scales. Read watts forward and reverse. A most accurate CB meter. Works like professional meters. Shows modulation. Graph for SWR included.



MACO 150

RECEIVE AMPLIFIER with dual gate MOSFET FOR HIGH GAIN AND LOW NOISE. Gain is adjustable from -20db to +27db (5 S units) with exclusive noise eliminator circuit. For SSB or AM Base Stations 110v AC operation.

Call or write for a free catalog and name of reseller near you.

CIRCLE 68 ON READER SERVICE CARD

new title, "Special Counsel for Amateur Radio Enforcement."

"It is still too early to tell," he said, "but it certainly won't mean less. You should expect to see the Commission's recent increase in enforcement activity continue." He noted that while the Enforcement Bureau was officially launched in October of 1999, it probably wouldn't be fully operational until early 2000. So, for the time being, nobody knows exactly how it will play out.

"One thing is certain," to paraphrase

Hollingsworth, "CB is in danger. Not from the FCC, but from itself. CB can be an important and valuable radio service. To the extent, however, that it appears to be a wasteland where nobody cares what happens on it or to it, it becomes increasingly attractive to others looking for a slice of radio spectrum." The point he makes is a valid one. The future of 11-meters rests not as much with the FCC as it does with the people who use it. In the end, what happens there is really up to us.

CALLING ALL OVER THE WORLD

GRUPPO RADIO ITALIA
ALFA TANGO

Division USA - State of NEW YORK



I. U. N. U. N. I. T. E. S. O. F. A. M. E. R. I. C. A. N. R. A. D. I. O. C. O. M. M. U. N. I. T. I. O. N.

TRAFFIC 100

30%

The final course of a QSOX is a QSL!

WE ARE NOT STRANGERS, JUST FRIENDS WHO HAVE NEVER MET

ONLY OPERATORS WITH ASCERTAINED QUALIFICATIONS CAN BELONG TO THIS GROUP

GRUPPO RADIO ITALIA

ALFA TANGO

INTERNATIONAL QX GROUP
Division: USA

2 AT 101

Op Jim
SUPER CLASS OPERATOR



P.O. Box 155, New York City, N.Y.
10471-0155 USA

SE SIGNAL ENGINEERING'S

High Performance CB & 10 Meter Antennas

SUPERHAWK

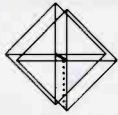

WHITE LIGHTNING THE Four Element Antenna

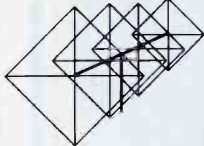

LIGHTNING 6

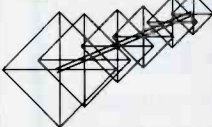

**Goldenrod
45 Spyder A+**
Broadband Hi
powered MOBILE

THUNDER 8
Hi Gain
Bi-Directional
OMNI
Electronically
Steerable

**And, also,
NEW QUAD
LIGHTNING 8**
THE most
POWERFUL
CB base in the
world today!

ALL SE PATENTED rotary beams are true quads and OUTPERFORM their counterparts (quad/yagi types). SE's patented SFS matching system makes SE QUADS the most technologically advanced antennas in the world today.

If your dealer doesn't have SIGNAL ENGINEERING, write or call for full specs. DEALER inquiries invited. MasterCard, VISA, AMEX, Discover

SIGNAL ENGINEERING

1172 Aster Avenue, #E, Sunnyvale, CA 94086
Phone: (408) 247-2300
Website: www.signalengineering.com

Lee Electronics

Scanners, SW, FRS and More:

AOR & Cobra Bearcat BoyGen
SANGEAN FREE PLAY uniden

1-800-578-6006

Tech: (724) 275-5822

www.LeesElect.com

Bill's 2 Way

CB Radio Equipment



uniden KENWOOD MIDLAND

CHEROKEE ICOM & Cobra

TEXAS RANGER maxon Galaxy

FREE CATALOG!

"We are the DISCOUNT LEADER
in sales of scanners, FRS, CB,
GMRS radios and accessories."

1-888-710-4094

Bill's CB & 2-Way Radio Service

PO Box 306, Morgan Hill, CA 95038-0306
Tech Line: (408) 782-0064 FAX: (408) 782-2985
e-mail: sales@bills2way.com
Website: <http://www.bills2way.com>

CIRCLE 63 ON READER SERVICE CARD



A look at the man behind the mic.

CB — Live On The Net

A recent development in two-way voice communications on the World Wide Web may eventually have the most impact of all. I am not talking about so-called CB-style chat rooms where you have to type your messages. I mean live, radio style communications where you key your mic and say, "How about it, can I get a break on this channel?"

In the past, the programs that made this kind of communications possible were only available to players of certain on-line games. Recently, however, several of these programs, including Roger Wilco and Fire Talk, have become available for use by the general public. You can get them free at www.resounding.com and www.firetalk.com. Others will soon be available as well. They are already changing the way people, including 11-meter enthusiasts, communicate over the World Wide Web.

Yes, long distance, dependable, multi-user, multi-channel, radio-style, Web-based communications are here at last. They rival and may eventually surpass most of what CB or amateur radio has to offer. No need for towers or antennas. Just fire up your computer and connect to the Internet, pick your channel, and key up.

As I write this, I am tuning through several forums (channels) on the Fire Talk system. If I did not know better, I would think that I was listening to some of the best CB I had ever heard. They refer to themselves as being "on-the-air," occasionally double-key, critique audio and technique, and so on. As I listen, I have to keep reminding myself that what I am

hearing is coming from my computer and not my radio. I also have to keep reminding myself that I am not listening to a group of locals, but people from across the country and around the world.

Some might see this as a threat to 11-meters. We will no doubt lose operators to the new medium. Fortunately, one of our biggest problems on the band is that there are often too many of us, so this could be good news. Others, however, see this as a way to enhance the band.

Take, for example, The United States Citizens Band Radio Operators Association. They are using a Roger Wilco channel set up on their web page at http://home.att.net/~uscb_association/ for organizational meetings. Soon, they hope

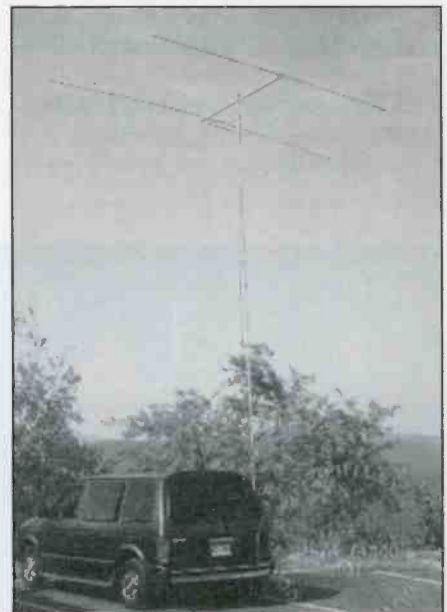

Here's the net control station.

to use it as an on-air simulator to train new CB operators, hold nets, host forums, and invite guest speakers.

Freeband Busts

Two Indiana hams, Bradley W. Vincent, KB9DUH, of Wilkerson, and Ernest C. Fulp, KA9ZWH, of Anderson, have received warning notices from the FCC. The notices claim that the Commission has evidence that Vincent and Fulp were "operating radio transmitting equipment on frequencies not assigned to the Amateur Radio Service, such as 27.425 MHz." The letters go on to request that they contact the Commission immediately to discuss the matter.

Not So Freeband

Asked to define the Freeband, most practitioners would point to the otherwise vacant frequencies above CB channel 40 and below the 10-meter amateur band. Others, however, would add the frequencies below CB channel 1 and the top of the 12-meter amateur band. Those frequencies, however, may not be vacant and operating there could be causing interference to legitimate users.

James "Rick" Sohl, Major CAP, Southwest Region CAP Deputy Chief of Staff/Communications, CAP West 4 writes to say that 26.620 MHz and 26.617 are allocated to the Civil Air Patrol. Major Sohl also reports that they often forced to move their operations to alternate frequencies due to "Freeband" activity.

Are there others? If so, our readers would like to know.

January And February Mixers

Looking for a little chatter on the CB? Then plan on attending the next, now regularly scheduled, on-air CB Mixer. They are held, wherever your are, on the last Saturday of the month (the next two will be on the 29 of January and 26 of February from 9 p.m. until 10 p.m. local time. SSB operators work channel 36 LSB. AM operators work channel 23. For complete guidelines, see the November 1998 issue of *Pop'Comm* or drop me a note.

Well, that's it for now. Thanks for writing me here at the magazine or via the Internet where my address <ed@barnat.com>. And as always, if you can (especially on January 29 and February 26) — catch me on the radio! 73



Receive Satellites with your Scanner!

Shuttle / Space Station / Military / etc.

Call for FREE brochure describing easy techniques to hear and see satellites.

Complete frequency guide with all orders!

1-888-FLIGHT-LN

(1-888-354-4856)

Flightline Engineering, Inc.

CIRCLE 72 ON READER SERVICE CARD

Wireless Internet & TV

**WIRELESS CABLE - IFTS - MMDS
ATV - INTERNATIONAL - DIGITAL**

Amplifiers • Antennas • Books • Components

• RF Frequency 2100-2700 MHz
• SASE For "FREE" Catalog or Send \$1

PHILLIPS-TECH ELECTRONICS

P.O. Box 737, 607 Parker St., Trinidad, CA 95570

CATALOG/INFO: 480-947-7700

ORDER LINE: 800-880-MMDS

FAX LINE: 480-947-7799

WEBSITE: www.phillips-tech.com

E-MAIL: product@phillips.tech.com

FREE SHIPPING Visa • M/C • AmEx • Discovery • COD's • Quantity Pricing

CIRCLE 70 ON READER SERVICE CARD

CQ Ham Radio's Best Calendars Are Back

NEW 2000-01 editions!

Hot off the press, our widely acclaimed calendar series is back with CQ's new 2000 editions. You'll refer to your CQ calendar time after time as you search for the schedules of upcoming ham events and conventions. Public holidays and valuable astronomical information will be right by your side too!

Enjoy 15 months of use (January 2000 through March 2001) with this year's editions. Each month you will be treated to some of the greatest photography in all of amateur radio.



Only
\$9.95 ea.
+\$2 s/h



2000-2001 Radio Classics Calendar— Enjoy this year's selection of 15 magnificent images of some of the finest in Ham gear, vintage 1935-1968. Collins, Drake, Lysco, Gonset, Eldico, Harvey Wells, Lakeshore, Hammarlund, Hallicrafters, Globe, and more.

The 2000-2001 Amateur Radio Calendar—The 2000-2001 CQ Amateur Radio Calendar—Features 15 terrific professional color photographs of some of the most interesting stations, the biggest antenna systems, the most famous operators and average hams throughout the USA.

Available directly from CQ and from your local dealer!

For Fastest Service call 1-800-853-9797 or FAX 516-681-2926

CQ Communications, Inc. 25 Newbridge Rd.,

Hicksville, NY 11801



The "Smokin' Gunn II" two element directional beam.

"Small in Size"

"Large in Performance"

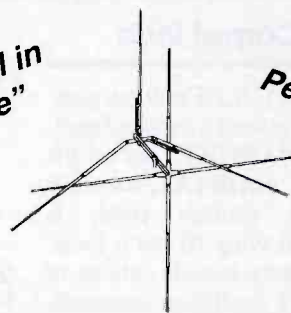

For information and pricing, contact any of the following Dealers:

Barker Electronics
Lawrenceville, IL
618-943-4236

J.C.R.E.
Woodland Park, CO
800-568-7752

Hi Tech Repair
Montgomery, NY
914-457-3317

TC Radio
Watha, NC
910-285-5841

Big Buffalo's Hide
Norwich, CT
800-455-1557

Hess Electronics
Doran, VA
540-963-3557

R & R Communications
Wilmington, DE
302-475-1351

Walt's CB & Scanner
Asheville, NC
704-254-3048

C & S Radio
Owings, MD
410-257-9481

Fry Enterprises
Nashville, TN
615-262-1862



3138 County Road 30
Ethelsville, AL 35461
(205) 658-2229 • Fax: (205) 658-2259

Hours: 9 a.m. - 5 p.m. (CST) Tues - Friday

Answering System After Hours

Check out our web site at

www.jogunn.com for "Monthly Specials"

Dealer inquires, please call.

communications confidential

Your Guide To Shortwave "Utility" Stations

New Caribbean Counter-Narcotic Net — Frequencies And Calls!

Hello everyone and welcome to the year 2000! I would say welcome to the new millennium, but contrary to all of the hype, the new millennium does not officially begin until January 1, 2001. Nevertheless, the New Year is in full swing and we wish you all the best that this year has to offer.

Now with winter in full force, I hope you are finding time to stay warm in front of your radios. There is always some good DX to be found during the winter months, and those snowy days off from work sure can add some unusual logs to the logbook. We would enjoy hearing from you all and to see what type of unusual stations you have been logging. Feel free to send us an E-mail or snail mail with a description of your recent logs or any other information of interest to UTE monitors around the world. Remember to send mail direct to us at P.O. Box 4450, Youngstown, Ohio 44515 and if a personal reply is requested, an SASE is always appreciated.

Magic Carpet Ride

Most monitors of U.S. HF military communications have at least a passing familiarity with the "HABITAT" net on the U.S. West Coast. HABITAT, formerly based at NAS Moffett field, is Commander Patrol Wing 10 and is located at NAS Whidbey Island, outside of Seattle. HABITAT is often in communication with the NAS Whidbey Island-based P-3Cs (see sidebar for frequencies). While HABITAT and the associated P-3Cs are well known, what is not so well known is the identity of another player in this net: MAGIC CARPET SIERRA.

MAGIC CARPET SIERRA is the SESEF (Shipboard Electronic Systems Evaluation Facility) at Keyport, Washington. While assigned a primary HF frequency of 3236 kHz, MAGIC CARPET SIERRA has also been copied on the HABITAT net frequencies 5700.4 kHz, 6719.4 kHz, 9011.4 kHz, and 11212.4 kHz. When operating as part of

the HABITAT net, MAGIC CARPET SIERRA often functions as a communications relay between units and HABITAT. I'd be interested in any logs on 3236 similar to those of SESEF Norfolk on 7535 kHz.

Caribbean Multi-National Narcotics Interdiction

Ron Perron checks-in this month from Maryland with some details on a rela-

OSL REPORT

Labrador Marine Communications & Traffic Services Centre

P.O. Box 720, Stn. "C"
Goose Bay, Labrador
Canada A0P-1C0

TF: 709-896-2252
FAX: 709-896-8455
Email: AndrewsGM@DFO-MPO.GC.CA

Labrador MCTS provides a full safety service to mariners with a continuous watch on 2182kHz, 500kHz, 156.8mhz and 4083kHz. We also provide weather information and Notices to Shipping in the form of broadcasts on Radiotelephone and Navtex. Weather information and Notices to Shipping are also broadcast continuously from April 15 to January 15 on VHF channels 21B from Goose Bay and 83B from Cartwright. Public correspondence service is provided by an international message service in Radiotelephony and Radiotelegraphy and ship-shore (Duplex) telephone connection.

OPERATIONS SITE	POSITION
Goose Bay Base Station.....	53.17.46N 60.32.35W
Hopedale Peripheral.....	55.27.25N 60.12.43W
Cartwright Peripheral Site.....	53.42.24N 57.01.30W

As the Officer in Charge, I am pleased to verify your reception of Labrador Coast Guard Radio, as follows:

Date: Dec 15 / 98 Time (UTC): 0146 Z
Freq: 2598 KHz USB

Equip: Nautel Transmitters 1000 Watts.
Antenna: Base-loaded 100 ft Tower (CW) and 120 FT broadband towers (RT)

73's
Officer-In-Charge

George M. Andrews
George M. Andrews

QSL received by reader Allen Renner, Ambler, Pennsylvania, from the Canadian Coast Guard's Labrador Marine Communications and Traffic Services Centre (MCTS) at Goose Bay, Labrador.

tively new multi-national, counter-narcotic net which is operating in the Western Caribbean. With communications occurring on 11178 kHz (days) and 6246.6 kHz (nights), this net has been active for the past couple of months. The organizations involved in the counter-narcotic operations seem to include the Dutch Navy, the Royal Navy, the French Navy, as well as the U.S. Navy, Coast Guard, and Drug Enforcement Agency. Individual units involved apparently include Dutch patrol vessels (c/s:

BY RICHARD "RD" BAKER <CommConf@concentric.net> and MIKE FINK <mikef@apk.net>

ORANGE GUARD, CHARLIE 1, and CHARLIE 2, a Dutch Navy helicopter (c/s: **HELUIS 519**); a French Navy vessel (c/s: **LIMA FOXTROT 3**) with an embarked helo (c/s: **LIMA FOXTROT 4**); U.S. Vessels (c/s: **SHARK ##** — USCG cutters, and **PIRAHNA SIERRA** — who is unidentified); U.S. Navy P-3 (c/s: **GREMLIN 0##**), as well as a Royal Navy vessel (c/s: **LORD NELSON**). Lastly, a vessel of unidentified nationality (c/s: **VICTOR ECHO**) has also been noted active in the net. This is possibly the French Navy.

Ron also points out that the long-time Dutch Navy Curacao net on **11178 kHz** is still active. Dutch Navy shore stations on this net include Suffisant (c/s: **PJK**), Hato (c/s: **PJC**), and possibly Bonaire (c/s: **PJX**). Aircraft active in this net use **FALCON ##** or **SPARROW ##**. In addition, two Dutch Navy F-27 maritime patrol aircraft from the 336th squadron at Curacao (c/s: **PE-MMA** and **PE-MMB**) have also been noted on the net.

A Little Off The Beaten Path

For a few years, individuals have been catching bits and pieces of non-oilrig related voice traffic on **4637.5 kHz**, but we have been unable to identify the source. These logs have appeared in this column, as well as other locations and have always remained unidentified. However, thanks to logs to the Worldwide Utility News (WUN) Club, we were able to do some research and at least some of the stations have finally been identified. The Middle Fork Lodge (c/s: **KOI811** . . . shortened to 811), located along the Salmon River in central Idaho, is the primary station on this frequency. Communications between the Lodge and various other stations take place around 1300–1400 UTC. Other stations include McCall Air Taxi (c/s: **WCE559**), Idaho Tele-Radio service (c/s: **WCE556**), Bob's Aircraft Inc. (c/s: **WNHT316**), and a probable station at the Sun Valley Airport (c/s: **SUN VALLEY 6**). The aircraft-related stations provide the only way into or out of the lodge area, and are used to ferry the visitors in from the various surrounding airfields. This is definitely an interesting frequency for those of you desiring a change of pace from the ordinary.

Other News

The U.S. Customs Service announced in September that it would establish a sec-

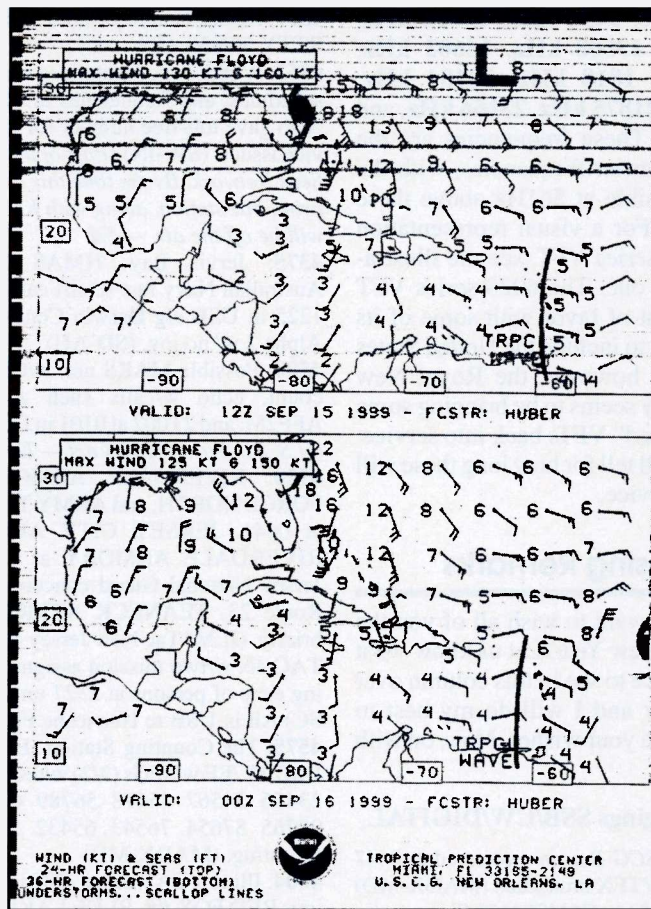

Weather FAX of Hurricane Floyd sent by NMG, USCG New Orleans at 2000 UTC on 12790 kHz captured by Robert Barbutas, Dolton, IL, using an M-800.

ond squadron of P-3 ORIONs for counter-narcotic operations. This squadron, to be based at Naval Air Station Jacksonville, will be modeled on a similar squadron located at Naval Air Station Corpus Christi. The squadron will consist of eight airframes, four of which will be the P-3 "Domes," equipped with an AWACS-type radar mounted in a dome above the airframe. The other four aircraft will be standard P-3Cs, nicknamed "Slicks" by the U.S. Customs Service.

Naval Air Station Jacksonville was selected as the home for this new squadron as it is already home to four U.S. Navy P-3C squadrons. The new squadron of aircraft should be fully operational by the middle of 2002.

The U.S. Coast Guard recently turned over one of their cutters for operation by a multi-national crew. To be based in Caribbean, the former USCG cutter *Gentain*, will operate out of Miami Beach. Its 44-member crew will include members from Trinidad and Tobago, the Dominican Republic, as well as the U.S. Coast Guard. Designated as a "Caribbean Support Tender," the 180-foot vessel will

perform a variety of duties to include search and rescue, humanitarian relief, and personnel training.

The Royal Australian Navy's guided-missile destroyer *HMAS Perth* was decommissioned on October 15, 1999 after 34 years of service. After many of her components are removed for reuse throughout the Royal Australian Navy, the *HMAS Perth* will be delivered to Western Australia where she will be sunk and developed as a site for recreational divers.

Digital News

The MidAtlanticDXer checks-in this month with a report about several recent "new" VFT stations active throughout the bands. Logged on **4083 kHz**, **5343 kHz**, **8019 kHz**, and **13459 kHz**, these stations are reportedly operated by the Royal New Zealand Navy from Irirangi, New Zealand (c/s: **ZLO**). Using "Barrie" 6028-series frequency/time division multiplexed VFTs, the Royal New Zealand Navy often runs two or three VFTs in parallel. Other frequencies listed for the

VFTs include: 9495 kHz, 10616 kHz, 11011 kHz, 13508 kHz, 15602 kHz, 15937 kHz, 1818 kHz, 20184 kHz, 20355 kHz, 21875 kHz, 23166 kHz, and 25523 kHz. These frequencies are the suppressed carrier frequencies, with the pilot tone visible at 561Hz above these frequencies. For a visual representation of the 6028-series VFT, see the illustration on page one. The 6028-series VFT had fallen out of favor with some of its former users, to include the United States and Canada, however, the Royal New Zealand Navy seems to be bringing some of their "retired" VFTs back into service. Only time will tell for how long these will remain in service.

Closing Remarks

Again, we want to wish all of you the best for this New Year. Let us know what you would like to see in this column over the next year and I will do my best to accommodate your wishes. Now, on with the show.

UTE Loggings SSB/CW/DIGITAL

518: NMF, USCG Boston monitored at 0447 in FEC w/NAVTEX broadcast. (MADX-MD) (removed now from CAMSLANT Chesapeake, VA — Ed)
2136: Czech stn, CZE at 0700 in USB w/9-tone call up + msgs read by a YL (AB-NL)
2357.5: OUA32, Danish Navy Aarhus, DNK at 2007 in CW w/VVV marker (AB-NL)
2670: CG Group Moriches (NY) at 0030 w/vessel Sea Breeze (sounds like) apparently in distress. Mention of using flares and wx conditions in the area of the vessel. Group Moriches at 0015 w/CG District 1 (Boston) Notice to Mariners BC. All in USB. (RP-MD)
2971: Gander Radio, CAN in USB at 0243 w/kg several a/c. (CS-SC)
3195: R, Russian Navy Ustinov, RUS at 2207 in CW w/channel marker. (AB-NL)
3322: R, Russian Navy Ustinov, RUS at 2208 in CW w/channel marker. (AB-NL)
3521: Spanish Navy at 2320 in USB, briefly w/EOK (67EOK) clg unreadable, weak. (AWH-FL)
3925: Tarheel Emergency Net (NC) in LSB at 0600 w/comms related to Hurricane Floyd, K4BNP, KA2NDY, and others taking turns as NCS as the morning progressed, ann of Floyd making landfall at Cape Fear, NC, still packing winds of 110 MPH, reports of power outages and flooding of low-lying areas. (JK-NY)
3950: N. FL emergency net chk-ins at 0117 in LSB re Hurricane Floyd. (MF-OH)
4295: FUE, French Navy Brest at 0324 in RTTY 75/800 w/call tape. (MADX-MD)
4325: R, Russian Navy Ustinov, RUS at 2117 w/channel marker. R, Russian Navy Ustinov, RUS at 2053 w/channel marker. All in CW. (AB-NL)

4337: RBSL, Bombay Radio, India at 0917 in RTTY 50/850. (EW-AU)

4363: WOM, w/computerized voice w/tfc list, schedules, and frequencies at 0100 in USB. Also gave toll-free number for customer service issues. (SW-IN) (Part of the AT&T High Seas Network. By the time this article goes to print, this station, along with KMI and WOO, will be off the air. — Ed)

4375: Jervis Bay, HMAS Jervis Bay, Australian Navy fast sealift catamaran 45, at 1225 in USB clg Darwin Control for r/c on Alpha 2 w/ no joy. (SD-AU)

4500: Possible MARS net, w/OM giving 10 count, echo w/calls such as AFAQX2, AFF2M, and 2T002 at 0101 in USB. (SW-IN) (U.S. Air Force MARS net — Ed)

4520: RIVERDALE ARMORY, TASK FORCE NORTH, and ARMY TOMS RIVER at 0441. JERSEY CITY ARMORY and RIVERDALE ARMORY at 1206 w/New Jersey National Guard concerning status of Route 23, TEANECK ARMORY also up briefly. (JLM) Tac New Jersey clg TAC 44 or TAC 4N w/two mission assignments involving evac of persons at 2327 until 2334. (CS-SC) All in USB re Hurricane Floyd.

4575: The Counting Station (E5) at 2323 in USB YL/EE w/5FGs (3/2) w/test msg. "12345 23456 34567 45678 56789 67890 09876 98765 87654 76543 65432 54321," then repeating. (MADX-MD)

4604: Illinois CAP net at 2230 in USB w/various RED FOX ##, BLUE LAKE #, and RED ROBIN checking into the net with and without tfc. (JK-NY) (Red Fox is Illinois CAP, Red Robin is Michigan CAP, while Blue Lake is unid CAP — Ed)

4739: FIGHTING TIGER 757 (P-3C, possibly NAS Brunswick) at 0102 w/1ER checking comms in clear and ANDVT. (RP-MD)

4940: Canadian comms net of some sort at 1400 w/two and three-digit numeric call signs w/177 as apparent NCS, 5155 given as secondary frequency. (JK-NY) Station CIP 77 w/32, 34, 64, 66, and CIP 301 at 1215 w/apparent communications exercise. Freqs 5845 (id as secondary) and 6980 also used by same net. (RP-MD) All in USB. (CIP calls are associated with the CFARS Canadian Forces Affiliated Radio Stations, the Canadian version of the MARS system — Ed)

5142.6: USCGC Point Batan (WPB-82340), out of Cape May, NJ, at 0035 in USB clg Group Charleston. (RP-MD)

5180: Cherta (S12) at 2103 in USB 371/00. (AB-NL)

5211: WGY9423, FEMA, unknown location and WGY912, FEMA, Berryville, VA, at 2350 in USB. COTHEN also checking into the net at 2354. (JLM-KY)

5297: RN UKSUBCAMS, G at 2018 in RTTY 50bd w/wx to HSWMS Soderman and "all subs copying this best." (AB-NL)

5320: NPBB, USCGC Block Island (WPB-1344) at 0026 in USB w/kg NNM37, USCG Group Fort Macon, NC, w/posn of adrift sea buoy, 33-36.75N, 076-58.35W, req Notice to Mariners broadcast re same. (RB-OH)

Abbreviations Used in Listening Post

AA	Arabic
BC	Broadcasting
CC	Chinese
EE	English
FF	French
GG	German
ID	Identification
IS	Interval Signal
JJ	Japanese
mx	Music
NA	North America
nx	News
OM	Male
pgm	Program
PP	Portuguese
RR	Russian
rx	Religion/Ious
SA	South America/n
SS	Spanish
UTC	Coordinated Universal Time (ex-GMT)
v	Frequency varies
w/	With
WX	Weather
YL	Female
//	Parallel Frequencies

5430: Unid, Missionary net Papua New Guinea at 0840 in USB w/2 OMs w/chit-chat. One of them mentioned about having to ride canoes to get access to some places and wanted to know what Jayapura in West Irian was like as he was going there shortly. (IJ-NZ)

5634: Mauritius Radio, Mau at 2132 in USB, Mauritius clg unid flight. (sec 3476). (EW-AU)

5643: SAM 28000 and Nandi Aeradio Fiji at 1830 w/U.S. President's Backup A/C enrt Auckland NZ for APEC summit, w/posn reports. AIR FORCE 1 and Auckland Aeradio New Zealand at 1850 w/U.S. President Clinton onboard also enrt to Auckland. First time in 33 yrs a U.S. President has visited NZ. Auckland Aeradio requests arrival time Auckland for AF1, estimated time was 2140 UTC. All in USB. (IJ-NZ)

5684: Vancouver Military monitored at 1242 clg ALPHA HOTEL 194 advising them to standby as they are having equipment problems, then requesting that they QSY to B7B. (SD-AU) 002 Malaysian Navy Patrol Boat at 1807 clg 9 MIKE BRAVO (MN Penang) w/no contact. First time since the early '90s, I've heard any MN Patrol Boat comms. They previously used 6563 as their primary channel. (IJ-NZ) All in USB.

5692: RESCUE 6026 clg East City Air for several minutes at 0150, no joy. (MR-MN) (Most likely they were calling "E-City Air", the nickname for CGAS Elizabeth City — Ed)

5696: CAMSLANT at 0358 in USB clg "unit in distress." At 0400, Group Eastern Shore clg "vessel in distress." At 0406, Group Charleston clg "aircraft in distress." At 0408, Group Mobile clg "aircraft in distress." No distress comms ever heard, all in USB. (MADX-MD)

5714: AUSSIE 234 clg Air Force Townsville at 1054 in USB for r/c, then advised there was no answer on the number and given an alternative number. (SD-AU)

6215: North Korea Spook in AM from

1200-1205, on w/martial mx into KR W 5FGs 2x, off w/out fanfare. (AWH-FL)

6246.6: VICTORECHO and OSCAR at 0242 w/mention of two exercises. (JLM-KY) GANTSEC (USCG Greater Antilles Section, San Juan, PR) clg SHARK 01 at 0016, ANDVT followed. GANTSEC clg FOX-TROT OSCAR at 0021, ANDVT followed. GANTSEC clg SHARK 07, tfc passed unheard at 0025. GANTSEC clg LORD NELSON at 0027. GANTSEC clg SHARK 19 at 2350. GANTSEC clg SHARK 21, passed tfc concerning a fishing vessel at 2346. GANTSEC later req 21 proceed to benchmark "PACKER" at 0003. All in USB. (MF-OH)

6470: Greek Navy Pireaus, GRC w/channel marker in CW at 0200. (RP2-TX)

6494.1: CWF w/meteo reports in RTTY, followed by a marine forecast for Newfoundland. (SW-IN) (CWF is an Uruguay Naval Station, most likely this was CFH, CANFORCES Halifax Nova Scotia on 6496.4 — Ed)

6693: Navy LK 04 (P-3C, VP-26 NAS Brunswick) at 0306 w/Rock Bottom (TSSC Rota Spain). Unit 7AU at 0324 w/unit IRY (over-modulated-hard to understand) in r/c in the clear and ANDVT, 7AU reports unable to complete mission. (RP-MD) MINIATURE and WAVERIDER 13 USN at 0936 w/an inquiry if they had rxed their msg, via Alligator, then into green comms. (IJ-NZ) All in USB. (MINIATURE is now located at Kanehoe Bay due to the closure of Barbers Point — Ed)

6694: Canadian Rescue 311 (CC-130, 413th Sqdn Greenwood) monitored at 2150 in USB w/Halifax Military, in pp w/Rescue Coordination Center (RCC) and Rescue 70 (unid). Coordinating SAR for unid vessel in St. Georges Bank area. Rescue 70 tasked to do a "coast crawl." (RP-MD)

6767.4: PAPA 9 INDIA 11 and QUEBEC 8 QUEBEC 89 at 0246 in LSB after multiple ALE connects. (JLM-KY)

6766: NGB26, National Guard, Johnston, IA, and NGB32, NG, Milford, MA, at 1428 USB after ALE. Other possible freqs 3032.0, 5217.0, 7648.5, 8093.0, 9121.0, 9141.5, and 10796. 149 BRIGADE and Frankfort, KY, EOC at 1825 w/antenna talk and mention of an upcoming test. All in USB. (JLM-KY)

6945: Czech Lady (S17) monitored at 1250 in USB. (AB-NL)

6961.2: NMC1, USCG CAMSPAC at 1047 in GTOR clg NSTF, USCGC Steadfast (WMEC-625), NRCB, USCGC Eagle (WIX-327), and wkg NGDF, USCGC Munro (WHEC-724). (MADX-MD)

7264: Unid maritime net, Bahamas at 1815 in LSB, incl K1LMC, C6AGH, C6AKV, mostly Americans around Marsh Harbour and Treasure Cay passing damage reports, also said tower for "Radio Abaco" was down. Also mentioned 3778 LSB as night freq after 1900. (AWH-FL)

7268: Bahamas Waterway Net at 1800 in LSB, incl WA3SSB, N4ICE, KA4TRG, KM4MA, mostly tfc concerning Hurricane Floyd damage on Man-O-War Cay, sunken boats exc 5,

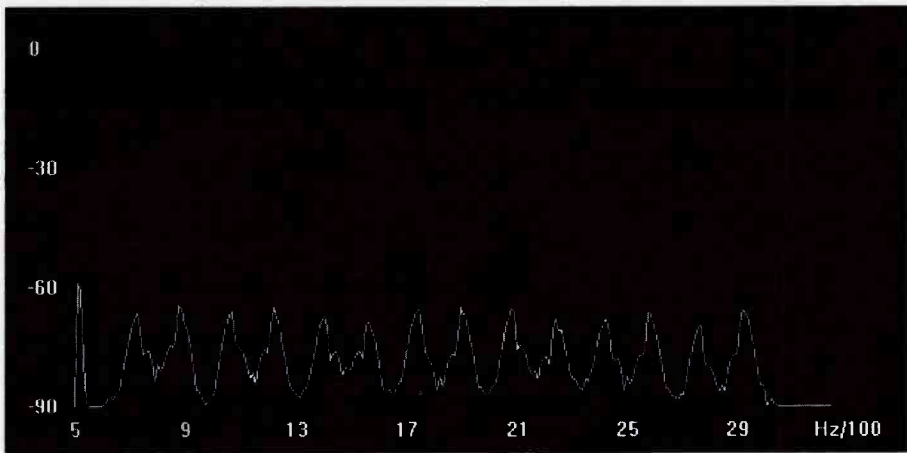

Royal New Zealand Navy 6028-series VFT running seven channels at 75bd/170Hz. Note the pilot tone at the left edge of the image.

house damage. Also using 7285 in LSB as discrete, passing HandW tfc. (AWH-FL)

7307: Unid, Cuba at 2315 in FSK w/"blob" data link w/ 4 tones, 4 kHz spacing, i.e. on 7301, 7305, 7309, 7313. When idle had carrier either on 7301 or 7313, so inverting at times. Repetitive sounding so maybe synchronous system. Possibly 200-300 baud. This is an unid Russian system, has been rptd there also. Very strong, sometimes also heard daylight hours around 6865. (AWH-FL)

7566: WPC at 1433 in FSK w/periodic PACTOR bursts followed by CW ID. Almost always here lately, any ideas? (AWH-FL) (This would be Pin Oak Digital on 7566.5, as detailed in the November 1999 column — Ed)

7841.5: WHISKEY NOVEMBER military net Malaysia at 1000 in USB, OM w/msgs, transferring 200 company. (IJ-NZ)

8047: NGB19, National Guard, St. Augustine, FL, at 1459. NGB1, National Guard HQ, Arlington, VA, and NGB32, NG, Milford, MA, at 1638 after ALE link. VDF and V8C, probable NG at 1705 switching to frequency 6 ALPHA. All in USB. (JLM)

8080: Philippines military net at 1030 in USB w/various stns passing msgs. (IJ-NZ)

8122: Jervis Bay clg Darwin Control at 1225 for r/c on ALPHA 4 w/no joy. (SD-AU) Canberra Control clg T9A at 0704 re heavy interference over test tapes on 8 Megs. (NJ-NZ) HMAS Fremantle (203) a Patrol Boat, at 1042 in USB wkg Canberra Control w/msg servicing. 1 immediate msg. (MADX-MD). All in USB.

8151: IGJ44, Italian Navy Augusta, I at 2110 in RTTY CARB. (AB-NL)

8189: USCG Group Mayport, FL, at 1233 in USB wkg I9C briefly, then gone. (AWH-FL)

8316: Navy Auckland clg Golf Hotel Juliet w/resend your testers line number 07 100 Alpha 4 at 0547. (NJ-NZ)

8338: Unid in VFT, 12 channels spaced 200 Hz at 2000. Couldn't measure speed or shift too fast? (JD-UK)

8335: DHJ59 (German Navy, Wilhemshaven) at 0203 w/vessel DRHH (FGS Oste Flottendienstb A-52) in clear speech and

RTTY. DRHH ref'd switching to 2ERV for tfc. (RP-MD)

8404: 2 x unid Russian ships at 0516 in ARQ w/simplex chatter re: poor conditions and nothing to do. (MADX-MD)

8418.4: DZX, Manila Radio, PHL in CW w/wx at 1000. //1100 (RP2-TX)

8522: 9WW, Kuching Radio, MLS in CW w/channel marker at 1130. (RP2-TX)

8530: IAR, Rome Radio at 0705 in CW w/ID and ann "Meteomar" wx bulletin to come on 521.5/4292. (HOOD-UK)

8549: UCE, Arkhangelsk Radio, RUS monitored at 1439 in FEC w/100bd msgs to various vessels. (AB-NL)

8586: USO5, Izmail Radio at 0630 in CW w/ID and QSW as USO6/USO5 525.5/4277. (HOOD-UK)

8588: RFTJE, French Navy Dakar at 0513 in RTTY 75/780 w/test tape. (MADX-MD)

8604: Unid in CW at 2045 w/message referring to various ships such as "Norwevskoe," "Transocean Searcher," "Sewernoe More, Rybolovnye," "Puluoenii," and "Kilxskaa Buhta." After a long time, it was finally identified as "cq cq de UIW." (PP-FR) (Kalingrad Radio — Ed)

8642.2: MGJ, RN Faslane, G at 2050 in RTTY 75bd CARB. (AB-NL)

8662: TAH, Istanbul Radio, TUR at 2058 in CW w/tfc list. (AB-NL)

8665: XSG, Shanghai Radio, CHN at 2057 in CW CQ (AB-NL)

8705.4: PKN, Balikpapan Radio, INS in CW w/marker at 1115, silence around 1130, then PKC. (RP2-TX)

8797: HLS, Seoul Radio, Kor at 1333 in USB w/pp to coast from fishing vessel off Port Hedland, WA. (EW-AU)

8803: OHG, Helsinki Radio at 0627 in USB wkg UIYD TKH Sormovskiy 306 for pp. (HOOD-UK)

8861: Yakutsk Radio, Urs at 1056 in USB w/Russian volmet. (EW-AU)

8867: Honolulu ATC at 1032 in USB w/Reach 532 (heavy) in posn report. (RP-MD)

8879: Bombay Radio, Ind at 1330 in USB clg Cathay flight for posn report. (EW-AU)

8882.3: Unid, at 0214 in USB w/unknown type of secure voice system in use. (RB-OH)
8965: Aussie 125 clg Airforce Auckland at 0046 for r/c, no reply to pp, later pp request to 03 51466444, "busy will call again in 5 mike." Aussie 125 clg Airforce Auckland at 0100 w/pp to SAN Ops passing eta for Norfolk Island of 0202. All in USB. (NJ-NZ)
8971: GREMLIN 02 clg/rsg BLUE STAR re LINK-11 and do they have their Papa Uniform for the alligator, and similar comms monitored at 0246. GREMLIN 02 wkg BLUE STAR monitored at 0330, ops normal, again talk of his alligator PU (password for entry into the LINK-11 net), also adv this is aircraft "603" when asked aircraft number, possible E-2C? (JK-NY) (*I'd agree, 601, 602, and 603 are E-2C 'nose' numbers — Ed*) Air Force Darwin at 0719 clg MIKE WHISKEY ZULU for r/c. (SD-AU) All in USB.
8974: ENVOY 601 (Dassault Falcon 50) at 0131 clg Air Force Sydney for selcal check, LP-EG and adv dep from Canberra at 0110, enrt Townsville w/ops nml. ARMY 24 clg Air Force Darwin at 1025 req they advise the relevant authorities of their arrival in Oakey. Jacobs Well clg Air Force Auckland at 2057 in w/SITREP no. 4 regarding exercise QUICK-START 99, advised by AFAUCK to QSY to 9010. (SD-AU) INTERFET 8348 clg Airforce Sydney w/standby Charlie Delta at 1106. Airforce Sydney clg Shepard 334 w/TAFYSRI (Richmond) YSNW (Nowra) YCOM (Cooma) at 2104. (NJ-NZ) RAAF Darwin, NT Australia at 0820 clg UNAMET Dili E.Timor for r/c. KIWI 337 and RAAF Sydney, NSW Australia at 0857 requesting if KIWI 337 could pick up extra paxs and cargo from Amberley for Darwin. (IJ-NZ) All in USB.
8980: CG 1502 (HC-130, Elizabeth City) at 1522 in USB w/CAMSLANT in pp w/CG District 5 (Portsmouth, VA). CG 1502 will recover back at Elizabeth City this evening after HurEvac to Charleston, WV, yesterday. CAMSLANT tasks 1502 to divert to Elizabeth City, NC, to escort CG 6026 (H-60, Elizabeth City) who is on medevac case 200 miles off the NC coast. (RP-MD)
8983: CG 1504 (HC-130, Elizabeth City) at 1904 w/CAMSLANT re 1504 will soon lose power and switches radio guard over to CAMSPAC Point Reyes. CG 1504 w/CAMSPAC reporting airborne from Charleston, WV, (hurricane evac location) enrt back to Elizabeth City. CG 1500 (HC-130, Elizabeth City) at 1910 reporting airborne from Charleston WV, enrt back to Elizabeth City. CAMSLANT Chesapeake at 2311 w/CG 2139 (HU-25, CGAS Miami) relaying information from Miami Ops that green and white vessel had been chased northward by Cuban Border Guards. 2139 posn is at 2557N/8051W. (RP-MD) All in USB.
8987: MKL, RAF Pitrevie Castle at 0502 in CW w/wx tfc for EGQT: Edinburgh, and EGXW: Waddington. (MADX-MD)
8989: JULIET 2 NOVEMBER at 2214 w/Australian military clg TANGO 44 w/tactical net including Y3G, G1U, and G8K.

YANKEE 3 GOLF at 1000 w/Australian military clg ALPHA LIMA 1 req termination of pp. YANKEE 3 GOLF at 1101 w/Australian military clg 9 ALPHA X-RAY for r/c, no joy followed by TANGO 44 also clg w/no joy. YANKEE 3 GOLF at 2232 w/Australian tactical net wkg HOTEL 8 KILO. (SD-AU) All in USB.
9007: TROJAN WARRIOR, C-130J delivery flight wkg Air Force Sydney at 2253 in USB, requesting pp to radio stn 2BL for interview. (SD-AU)
9010: JACOBS WELL at 2058 clg Air Force Auckland and advising them of their arrival at Jacob's Well, Queensland, Australia w/SUNRAY MINOR being advised by SUNRAY at Jacobs Well that they are about to depart for Amberley and that they will arrive in time for departure at 1500 for Ohakea, New Zealand and SUNRAY MINOR wishing them the best and that he'll see them back in New Zealand. (SD-AU) RAF VOLMET at 0136 w/airfield wx conditions. (RP-MD) All in USB.
9016: AUTO SALE clg/rsg PORTABLE at 0230, asked AUTO SALE if he wanted to check into the net. AUTO SALE responded that he had already checked into the net under pre-0000z callsign (which had been SEA TRAIN, I believe), also advised PORTABLE that he had checked STANWICK out of the net earlier. AUTO SALE indicated he would check out of the net in the blind in about 25 minutes. (PORTABLE was the NCS). The NCS appears to be unaware of the status of the other players in the net unless they remain in HF radio contact with the NCS. (JL-NY) WAR46 wkg ROWBOAT for r/c at 1116. (NJ-NZ) Reach 125 Sierra in pp at 2245, advises is on ground at O'Hare, landed at 2230, and will depart "on frag." Gave tail number as 40068. QSY from 13200. (MR-MN) All in USB.
9023: (Andrews) at 0721 in USB w/testing on F467. (IJ-NZ) Andrews w/pp for NAVY 496 at 1950. (MF-OH) All in USB.
9024: St. Petersburg Air, RUS at 1026 in USB wkg unid aircraft. (AB-NL)
9034: Unid, possible military comms monitored at 0825 in USB w/YL passing aviation wx in SS. (SD-AU)
9035: Unid, possible military comms at 0825 in USB w/OM using NATO phonetic alphabet, and passing aviation wx in SS. (SD-AU)
9040: M12 monitored at 2108 w/CW in progress. (AB-NL)
9062: M8: Cuban cut numbers station at 0534 in CW w/5FGs already in progress. Down at 0536 w/AR AR AR SK SK SK. (MADX-MD)
9081: Unid, VFT w/3 channels spaced 680 Hz w/192 bd FEC-A encrypted at 1500. (JD-UK)
9120: CACTUS wkg PORTABLE monitored at 0119 in USB and data, some selscan also noted. (JK-NY) (*CACTUS is reportedly the Camp David Comms Center and heard here infrequently — Ed*)
9122.5: WUG, USACE Vicksburg at 1500 in USB w/ALE and 1500Z USACE Net. Stations include WUJ1, WUE7. Low net turnout, with most members of roll call not answering. (MADX-MD)

9145: FORT LAUDERDALE BASE and ARCTIC CIRCLE at 1259. SHADOW 05 clg SHADOW 06 at 2052, CLH also heard here but not sure if it's related to the SHADOW calls. Previously reported as CL-8. (JLM-KY)
9158.6: HBD 20, MFA Berne Switzerland at 0532 in ARQ w/alot of OP chat, ended w/73s Rudi. (IJ-NZ)
9185: WWJ98 and AAR4???, U.S. Fed Govt Region 7 net FHWA Shoshone ID, and Unid MARS stn at 0520 in USB, 2 OMs w/chit-chat. Mentioned about earthquakes, seismic monitoring, TV broadcasting, skeds, and radio propagation. Ended with thanks for the r/c. (IJ-NZ)
9251: E3, Linc. Poacher, CYP at 2100 w/id 08847. (AB-NL) Unid, number stn at 2125 w/lady reading 5L grps. (EW-AU) All in USB.
9330: M8: Cuban cut numbers station heard at 1202 in CW w/ID: 80430. Into cut 5FGs. (MADX-MD)
10057: Unid radio w/selcal to United 837 at 2215. (BF-NM) (*San Francisco ATC often reported here — Ed*)
10100.8: DDK, Hamburg Meteo, D at 1015 in RTTY 50bd w/wx. (AB-NL)
10144: DK0WCY, DARC aurora beacon, D at 1030 in CW w/propagation info. (AB-NL)
10220: Unid, Piccolo-6 channels 1, 2, and 4 of a 4-channel system, no ID seen at 1530. (JD-UK)
10275: RYM4, URSI Moscow, RUS at 1007 in USB w/wx in Russian. (AB-NL)
10306.5: OLZ88, MFA Prague, CZE at 0934 in CW testing OLZ7. (AB-NL)
10493: ATHLETIC COACH at 1623 in USB w/"H" msg for APACHE KID. (JLM-KY)
10555: AXI34: Darwin Meteo at 1127 in FAX 120/576 w/end of chart. (MADX-MD)
10588: WGY908, FEMA, Denver, CO, and WGY957, State EOC, Lincoln, NE, at 1541 in USB. (JLM-KY)
10631: M42 FAPSI, RUS at 1610 in RTTY 50bd in progress. (AB-NL)
10774: E07, English Man, RUS at 2010 in AM 172 000. (AB-NL)
10780: STARGATE (JSTARS E-8C, backend callsign) wkg Cape Radio at 1648 w/pp to DSN# 497-2612, passes formatted report: "Line 1: 1407, Line 2: 1643, Line 3: 1630." (ALS-FL) Cape Radio at 2222 w/King 33 (USAF Rescue C-130) in pp to DSN 854-XXXX Patrick AFB w/request for wx at Stephenville Canada. (RP-MD) All in USB.
10952: HBD20, MFA Bern, S at 1010 in ARQ 100bd w/encrypted msgs to various embassies. (AB-NL)
10969: HBD20, MFA Berne, SUI at 0840 in ARQ 100bd w/encrypted msgs. (AB-NL)
11143: BRAVO 9 CHARLIE Australian Military Possibly E.Timor related at 0715 in USB clg NOVEMBER 5 SIERRA for r/c w/no joy. (IJ-NZ)
11174: Several pp's between unid military people and family, the request for message forwarding was identified as "Telegraf" with name interchange, language look like Israeli to me at 1300 in USB. (LA-IA)
11175: Teal 23 (probable WC-130, Keesler AFB) at 0014 w/Andrews in pp w/local

Habitat Frequencies

4704.4	5700.4
6719.4	8978.4
9005.4	9011.4
11212.4	15095.4

(Caribbean area) media on situation inside Tropical Storm Dennis. Speaker sounds like media person who is relaying impressions and sightings to fellow media person "Flash" on the ground. (RP-MD) All in USB. *(Just FYI, the WC-130's at Keesler AFB have been replaced by the new WC-130Js — Ed)*

11178: VICTOR ECHO w/kg SHARK 17 (probably USCGC Vigilant WMEC-617 but could also be USCGC Attu WPB-1317) at 0341. proceeding to intercept and cut off go-fast. Target vessel tracking 245. At 0349, VE adv target now Dead In Water (DIW). SHARK 02 prob USCGC Tampa WMEC-902, but could be USCGC Manitow WPB-1302, or USCGC Madrona WLB-302) and ORANGE GUARD up re; same. (RB-OH) VICTOR ECHO w/SHARK 17 at 0535, understand only warning shots at this time. VE w/SHARK 17 at 0539, weapon of choice 50 caliber will deploy when along side. VE w/SHARK 17 at 0629, confirm you are opening fire on the go fast. (NJ-NZ) PJK and GANTSEC, DN Curacao Netherland Antilles and USCG San Juan Puerto Rico at 0435 both w/kg VICTOR ECHO. (IJ-NZ) All in USB.

11181: Man Drill at 0235 w/McClellan in HF data transfer. (RP-MD)

11184: Japanese Military at 0711 in USB w/WX forecasts. (IJ-NZ)

11199: Y3G clg T44 w/radio check at 2323. J1A clg T44 w/message "CHAIR OVAL GRADE 7 PINE HAND" at 0720. (SD-AU) All in USB.

11202: CAMSLANT w/kg B1K (apparently USCGC or USN vessel) at 1431 passing B1K a shoreline search pattern as follows, Cape Sable to Cape Romano, then three miles inland, then back to Cape Sable, then repeat. Stated target unknown and instructed B1K "Pass that on to your unit," also asked B1K "Will your unit need to refuel?" and made reference to refueling at Clearwater. (JK-NY) All in USB.

11205: Foxtrot 6 Tango clg Papa 3 Delta at 0825, be advised we are not in contact w/Zulu 8 Bravo at this time. (NJ-NZ) ROMEO ROMEO 1 and FOXTROT 6 TANGO Australian Military E.Timor net at 0732 w/radio checks. INTERFET (International Force E.Timor) 1061 and RAAF Darwin, NT Australia at 0650 w/selcal check. UN 006 and RAAF Darwin, NT Australia at 0654 w/operational within 30 nautical miles. (IJ-NZ) All in USB.

11214: RAZOR 05 at 1634 w/pp to RAYMOND 19 through Trenton Military. As they talked to RAYMOND 19 on 11214, they were simultaneously transmitting on 303.0 MHz

(AM), where they had earlier contacted SODA CONTROL. (JLM-KY) DARKSTAR MIKE clg sig check at 1933. (MF-OH) All in USB.

11220: SAM 403 and Andrews monitored at 0746 in USB on primary F311. SAM 403 was returning Stateside after being used as AF1 for U.S. President Clinton's trip from Auckland to Queenstown NZ. The usual AF1 wasn't suitable for Queenstown's smaller runway. (IJ-NZ)

11221: LIMA BRAVO 01, presumed military net Philippines at 0752 in USB passing wx forecasts LIMA BRAVO 01, Omega, Partly cloudy. (IJ-NZ)

11232: CANFORCE 2861 at 2326 clg Trenton Military who advises no pp's on this frequency and to QSY 17994. (SD-AU) Canforce 2427 at 1339 w/Trenton Military w/request for wx at Frobisher Bay. Canforce 2437 w/request at 1342 for wx at Montreal, Trenton, and Ottawa. Trenton Military at 0232 w/Canforce 2107 req wx for Las Americas and Puerta Plata, both in the Dominican Republic for 0305 arrival. Also r/c on 13257. (RP-MD) All in USB.

11235: UNITED NATIONS 065 at 2303 clg Air Force Darwin w/ops nml message and advising arrival in Dili (East Timor) at 2335. CANFORCE 1 at 2314 clg Air Force Darwin w/no joy. CANFORCE 1 at 2314 clg Air Force Darwin w/no joy. Air Force Darwin clg UNAMET DILI at 0625 for r/c and has them 1 and c. (SD-AU) Ascot 2024 and RAAF Darwin NT, Australia at 0744 w/Selcal check. (IJ-NZ) Airforce Auckland clg Kiwi298 re air moves requests their intentions at this time, signal faded at 2306. (NJ-NZ) All in USB.

12242: USCG Cutter METOMPkin (WPB-1325) clg CAMSLANT at 0144, nothing heard. F6XR clg NMN at 0155, nothing heard. (MF-OH)

11247: Qantas Control clg Qantas 59 w/pp to Qantas control for wx via Airforce Townsville at 0703. (NJ-NZ) Qantas 59 and RAAF Townsville, QLD Australia at 0706 w/pp to Qantas Control passing WX for Osaka. (IJ-NZ) All in USB.

11250: AXF, RAAF Sydney, NSW Australia and AUSSIE 165 at 0358 in USB terminating pp. (IJ-NZ)

11285: 9VG, Singapore Radio, Sng at 1151 in USB clg Ansett flight w/pos info. (EW-AU)

11300: Tripoli Radio at 2055 in USB w/kg several a/c, Nairobi Radio also heard. (CS-SC) 11339: 82824 and Nandi Aeradio Fiji at 0705 in USB with a/c returning due to pressurization problems. Leaving FL140 and going down to 9000ft. (IJ-NZ)

11387: Sydney VOLMET at 1000 in USB w/aviation wx. /6676/. Singapore VOLMET at 1021. (MADX-MD)

11578.5: RAN Exmouth WA, Australia, at 0955 w/VFT 16 Channel Xmission. (IJ-NZ)

11565: Unid YL in SS in AM at 0302, w/5F msg and "Attencion" before groups. (CS-SC) *(This would be the "Attencion" numbers station from Cuba, Enigma designator V2 — Ed)*

12186: E07, English Man, RUS at 2000 in AM 172 000. (AB-NL)

12473.5: UHQZ TK Volgoneft 142 at 0611 in

CW w/admin from Km Dimov to Samara. (HOOD-UK)

12478: UBSW TKH Tekhnolog Konyukhov at 1049 in ARQ w/posn rpt to UCE. UHCK TKH Kapitan Glazachev at 0726 in ARQ w/admin from Km Kiryakov to UCE. UCNT TKH Kapitan Mochalov at 0732 in ARQ w/admin/psn rpt to UCE (14203dwt bulker). UCKT TKH Iohann Mahmastal at 0735 in ARQ w/crew TGsto UCE (7075dwt gen cargo vsl). (HOOD-UK)

12484.5: 9HMZ5, M/V Pioneer at 1227 in ARQ w/msg to NAVIBULGAR via LZW (10422dwt cont carrier). (HOOD-UK)

12512.5: UTXB, TKH Donetsk at 0653 in ARQ w/admin from Km Lysenko to USU. (HOOD-UK)

12522: VTCJ, M/V Ratna Deep 1053 ARQ AMVER via SAB login 23697 RTNDP. (HOOD-UK)

12538.5: URAZ, TKH Valerian Zorin 0722 RTTY 50/170 crew TG to US05. (HOOD-UK)

12546: UTSL, RTMKS Saturn monitored at 0722 in RTTY 50/170 w/crew TGs to URL. (HOOD-UK)

12556: UWRY, RTMS Znamya Truda at 0630 in RTTY 50/170 w/crew TG to URK9. (HOOD-UK)

12560.5: UGZI SRTM Torok at 0635 in RTTY 50/170 w/admin to UIW. (HOOD-UK)

12561.5: J8LL7, M/V Alexa at 1058 in RTTY 50/170 w/admin to Moskva Rybflotinvest via UIW (ex-Aleksandr Ivanov). UFDR TSM Olshana at 0633 in RTTY 50/170 w/admin to UIW. (HOOD-UK)

12579: NMO, Honolulu Radio, USA at 2345 in FEC 100/170 w/warnings and wx. 9VG, Singapore Radio, Sng at 2353 in CW w/stn marker. (EW-AU)

12599.5: UAT, Moscow Radio, RUS at 1007 in USB w/marker. (AB-NL)

12603: E03, Lincolnshire Poacher, CYP at 2100 in USB w/id 08847. (AB-NL)

12691.2: RFVIE, Le Port Radio, monitored at 2215 in RTTY 75/850 w/faaa de rfvie line test. (EW-AU)

12735: URL, Sevastopol, Ukr., in CW from 1500-1600. (PP-FR)

12736: LSD836, Buenos Aires Radio, Arg, at 1218 ARQ w/short telex msg in EE. (EW-AU)

12742: CBV, Playa Ancha Radio, CHL w/120/576 w/fax at 2310. This frequency parallel //17146.5 //8677.3. (RP2-TX)

12808.5: VTG, IN Mumbai, IND, in CW w/channel marker at 1230. (RP2-TX)

12815: LYA, Klaipeda Radio, LTH in CW w/tfc list at 1000. (RP2-TX) LYL, Klaipeda Radio, LVA at 1009 in RTTY 50bd Cw + RTTY w/msgs to various vessels. (AB-NL)

12823.5: CTP, NATO Oeiras, POR at 1708 in RTTY 75bd clg NAWS. (AB-NL)

12856: XSG, Shanghai Radio in CW w/CQ CQ DE XSG from 1500-1600. (PP-FR)

12966.5: A7D, Doha Radio, Qat at 1308 in CW w/stn marker. (EW-AU)

12970.5: PKX, Jakarta Radio, Ins at 1306 in CW w/stn marker. (EW-AU)

13010: AQP, Karacki Naval, Pak at 1304 in CW w/stn marker. (EW-AU)

13022: SPE, Szczecin Radio, Pol at 1300 in FEC w/stn and freq info. (EW-AU)

13042.7: RFQPM, Djibouti Radio at 2228 in RTTY 75/850 w/ry line test faaa de rfqpm. (EW-AU)

13055: UTQ7, Kiev Radio, Lva at 1255 in CW w/stn marker. (EW-AU)

13200: YANKEE 3 GOLF at 0417 clg TANGO 44 for r/c followed by Y3G advising that pp is connected w/JULIET 2 NOVEMBER, adv he had not called for pp and was adv by Y3G that this was a continuous pp followed by J2N requesting news of confirmation of his request from T44. T44 replying w/challenge process using codewords and advising he has nothing for J2N. J2N then requests T44 to FAX a copy of his flight approval to unid which was followed by bursts of ANDVT. T44 then calls Y3G followed by AUSSIE 60? clg Air Force Darwin (signal strengths and voices suggesting Y3G was AFDAR and AUSSIE 60? was J2N). This was followed by a flurry of ANDVT and the circuit went QRT. All in USB. (SD-AU)

13248: BLACKHAWK 213 at 0344 in USB clg Air Force Sydney requesting pp to School of Army Aviation Operations. (SD-AU)

13264: Shannon Volmet at 1002 in USB w/aviation wx. /8957 weak/. (MADX-MD)

13430.5: VTK, Tuticorin Naval, India, in CW w/"VVV VTK 3/4/5/6/7" // 19450 at 0930. (JD-UK)

13459: Prob ZLO, RNZN Auckland monitored at 1227 in VFT w/7ch x 75/170. Barrie VFT. (MADX-MD)

13510: CFH, CANFORCES Halifax at 1323 in FAX 120/576 w/blank signal. Also in RTTY 75/690 at 1451. (MADX-MD)

13543.7: Prob RFTJD, French Forces Libreville at 0441 in ARQ-E3 192/380 idle. (MADX-MD)

13580: HMF35, KCNA Pyongyang at 1237 in RTTY 50/200 w/EE nx. Decent signal. (MADX-MD)

13886.7: RFFA, Paris, France at 0615 in ARQ-E3 192/425 w/idling only. (EW-AU)

13953.2: NMC, USCG CAMSPAC at 0315 in GTOR 100/200 clg NYCQ: USCGC Boutwell WHEC-719, NLVS: USCGC *Rush* WHEC-723, and NNHA: USCGC *Acushnet* WMEC-167. (MADX-MD)

13981.7: Paris, France at 2105 in FSK E3/100/400 w/CdV ckt IRE. (AWH-FL) (*Circuit IRE, runs from MOD Paris to Le Port, Reunion — Ed*)

14160: RPFNG, Portugues Navy Alges, POR at 1314 in RTTY 75bd w/msg to RPFNN Lisboa (AB-NL)

14396.5: VL8IPS, Ionispheric Prediction Service Radiosonde Darwin, NT Australia at 1050 w/CW marker and data bursts. (IJ-NZ)

WPEH727, AT&T, Bedminster, NJ, at 1617 in USB, also KHA925, Johnson Space Center, Houston, TX, at 1631. (JLM-KY)

14407: PK-OCZ, Unid a/c Indonesia at 2202 in USB clg w/no joy. (IJ-NZ)

14425: CIA Counting stn at 2108 in USB, YL w/numbers. (IJ-NZ)

14450: Presumed Ferry Boat net Philippines at 0650 in USB w/OM relaying operational Msgs. Oil Pressure, Engine No 4, Bulova Citizen, For ferry No1 Bulova Citizen, For ferry No2 Bulova Omega Oil, and water pressure, etc. (IJ-NZ)

14467: NNNOCAY w/COLONEL LADY at 0120 in USB wkg NNN0UTO w/pp's. Ship located west of Mexico, heard until 0219. (CS-SC) (*Navy MARS — Ed*)

14470: NNNOCOL w/MARS stn NNN0TWT in Jacksonville, FL, at 2345 in USB w/several pp's until 0002. (CS-SC) (*More Navy MARS, NNNOCOL is the USNS Indomitable (T-AGOS-7) — Ed*)

14487: E03, Lincolnshire Poacher, CYP at 1200 w/id 62435 //15682. M03, Lincolnshire Poacher, CYP at 1700 w/id 49830 (AB-NL) All in USB.

14518.5: VHC, RAN Belconnen, ACT Australia at 1055 w/VFT 16 channel Xmission. (IJ-NZ)

14532: U3H, French Embassy, Moscow monitored at 1315 w/192 bd FEC-A wkg "P6Z" (MFA Paris). Shift 850 Hz — unusual for FEC-A. (JD-UK)

14585.7: RFPTC, N'Djamena, Chd at 0631 in ARQ-E3 200/425 w/idling only. (EW-AU)

14633.3: RFLI, Fort de France, Mrt at 0553 in ARQ-E3 192/425 w/idling only. (EW-AU)

14719: OST, Ostend Radio Belgium at 0640 in FEC w/tfc list. (IJ-NZ)

14720: M42, FAPSI, RUS at 1454 in LSB w/6-tone selcal + unreadable RTTY. (AB-NL)

14790: Presumed shipping net in Philippines at 0910 in LSB w/OM passing operational msgs. Discharging load, metric ton, maneuver to low side, officer onboard, pull up anchor, full ahead engine, half to full ahead engine, position united yankee yankee kilo kilo, water is light, position juliet united yankee yankee tango kilo, same course, passengers secured onboard. (IJ-NZ)

14959.7: RFTJ, Dakar, Sen at 0622 in ARQ-E3 192/220 w/idling only. (EW-AU)

15016: QUEBEC 905 in pp to unid at 2000, advised was off deck at 1910, will be on deck at Springfield at 2115. (MR-MN)

15021.5: AXH, (presumed) RAAF Townsville QLD, Australia at 1005 w/VFT 16 Channel Xmission. AXH is the only RAAF base listed using VFT on the freq, but the RAAF has supposedly phased out the VFT mode and now only uses PSK modems. (IJ-NZ)

15076: YANKEE INDIA and YANKEE DELTA Japanese Military at 0553 in USB w/CRATT co-ord. (IJ-NZ)

15085: Qantas 15 and RAAF Perth, WA Australia at 0848 in USB w/pp to Qantas Control Maintenance. Qantas 15 had been struck by lightning, only damage suffered was to the standby compass. Maintenance wanted to know if it was a forward or rear strike, 15 wasn't sure. Maintenance suggested they get the a/c checked out once it had landed in Bangkok. (IJ-NZ)

15637: Unid Russian Diplo at 1329 in CROWD36 40bd. Strong signal. (MADX-MD)

15682: Lincolnshire Poacher, CYP at 1200 in USB w/id 62435. //14487 (AB-NL)

15922.7: VHC, RAN Belconnen, ACT Australia at 0340 w/VFT 16 Channel Xmission. (IJ-NZ)

15961.7: RFLI, Fort de France, Mrt at 0030 in ARQ-E3 192/400 w/idling only. (EW-AU)

16000: VNG, Time Station at 1344 in AM w/time signal and voice announcement. Weak, but readable. (MADX-MD)

16077.7: RFFTD, French Force, Frn at 0634 in ARQ-E3 192/425 w/idling only. (EW-AU)

16079: Unid in Piccolo, Channels 1, 2, and 4 of a 4-channel system, no ID seen at 1915. (JD-UK)

16084: Lincolnshire Poacher at 1302 in USB w/music and id 21855. Also at 1400 w/id: 06750. (MADX-MD)

16091.7: Egyptian Diplo at 1355 in ARQ w/5LGs. QRT at 1358. Strong signal. MFA Cairo and Egyptian Embassy Washington logged here in the past. (MADX-MD)

16143.7: RFLI, Fort de France, Mrt at 0631 in ARQ-E3 192/425 w/idling only. (EW-AU)

16193.2: RFQP, Djibouti, Dji at 0608 in ARQ-M2 200/425 w/idling only. (EW-AU)

16238: W5E, French Embassy, Tel Aviv, Israel in 192 bd FEC-A, also some opchat on CW w/5L groups to "RFGW" at 1745. (JD-UK)

16245: U3H, French Embassy, Moscow at 1305 w/192 bd FEC-A wkg "P6Z" (MFA Paris). (JD-UK)

16310.2: RFFA Paris Radio, Frn at 0617 in ARQ-E3 200/425 w/idling only. (EW-AU)

16318.5: 7RQ20, Algiers Radio, Alg at 0818 in COQ 8 26.7 w/french text. (EW-AU)

16357: Unid, Picc-6 channels 1, 2, and 4 of a 4-channel system; Ch 1 and 4 idling; no ID seen at 1600. Presumably the same stn previously reported on 16079. (JD-UK)

16914.5: SPB, at 1600 in FEC w/tfc list. (PP-FR) (*Szczecin Radio, Poland — Ed*)

16923: OFJ, Helsinki in CW w/tfc list from 1500-1600. (PP-FR)

17050: 4XZ, Israeli Navy (only the callsign made sense) in CW. (PP-FR)

17074: LGX, Rogaland, Norway, in CW w/tape ann freq for tfc list. (PP-FR)

17180: FUG, French navy La Regine, F at 1040 in RTTY 100bd w/test tape. (AB-NL)

17422.7: RFFVAE, Dharhan, Ars at 0640 in ARQ-E3 200/425 w/idling only. (EW-AU)

17519: M42 FAPSI, RUS monitored at 1410 in RTTY w/75bd Msgs to RXC81 on link 30088. (AB-NL)

17919: ARINC Radio: prob Riverhead, NY, at 1943 w/HF ACARS squitter. (MADX-MD)

17994: Trenton Military at 2327 clg CANFORCE 2861 who was weak readable. (SD-AU) J? and 5 QUEBEC YANKEE Japanese Maritime Self Defence Stations at 0603 coordinating a datalink. (IJ-NZ) All in USB.

18018: ARCHITECT w/airfield color states at 1231. M (SP) at 1235 in USB in chatter w/possible aircraft. Reference to possible place name Mariel. (RP-MD)

18172: Unid FAPSI stn clg URS at 0835. In contact w/the stn on 16257. RJA, unid FAPSI stn comes on w/CW and calls "URS" at 0835 daily; "URS" answers on 16257. (JD-UK) All in RTTY 75/500.

18261: GFE24, Bracknell Meteo monitored at 1743 in FAX 120/576 w/beginning of chart. (MADX-MD)

18373: M42 FAPSI, RUS monitored at 1500 in RTTY 75bd w/msgs to UDZ21 on link 00054 (AB-NL)

18415.1: 8BY, French Intelligence (M16) at 1748 in CW w/"vvv vvv vvv 8by 8by 8by 302 / 459 / 463 / 015." (MADX-MD)

18503.7: RFFA, Paris, France, at 0642 in ARQ-E3 192/425 w/idling only. (EW-AU)

18783: Shipping net Philippines at 0822 in USB w/YL and OM in Tagalog. Mentioned about boarding passes. (IJ-NZ)

18966.7: RFHJ, Papeete, Tahiti at 0647 in ARQ-E3 96/425 w/idling only. (EW-AU)

19048.7: RFFA, Paris, France, at 0649 in ARQ-E3 192/425 w/idling only. (EW-AU)

19101.7: RFLI: French Forces Fort de France at 2046 in ARQ-E3 192/364 CdV on ckt [BFL] to Paris. One of the cleanest signals I've ever heard from RFLI. (MADX-MD)

19131: FLINT 418 on frequency "SJ" c/g ATLAS, enr BLUEGILL 200 at 2345. FLINT 931 leaving SUNDANCE 200 req pp at 2115. FLINT 453 rep ops normal to ATLAS at 2130. All in USB. (MF-OH)

19283: MKD, RAF Akrotiri, Cyprus w/2-channel Piccolo-6 w/kg MUH at 1030. (JD-UK)

19450: VTK, Tuticorin Naval, India in CW w/"VVV VTK 3/4/5/6/7" parallel w/13430.5 at 0930. (JD-UK)

19687: KHF, Guam Radio at 0457 in CW w/stn marker. (EW-AU)

19696.5: 8PO, Barbados Radio at 1425 in ARQ w/repeated c/s: DUSP: MV Serra (15,022 dwt freighter). No t/c noted. (MADX-MD)

19736.5: ZLA Awarua Radio, Nzl at 555 in CW w/stn marker. (EW-AU)

19843.9: Unid 4-tone system at 1500 w/195.2 bd, +300 +100 -100 -300 Hz. Frequently reported, never identified. (JD-UK) (*Is it a coincidence that those same tone frequencies are used by some Twinplex setups? Possible Twinplex modification? Anyone? — Ed*)

20179.7: RFFA, Paris Radio, Frn at 0653 in ARQ-E3 100/425 w/idling only. (EW-AU)

20326.7: RFVI, 1120 Le Port Radio, at 1120 in ARQ-E3 100/425 w/idling only. (EW-AU)

20556.5: P6Z, Paris Radio, Frn at 0905 in FEC-A 192/425 w/diplo messages. (EW-AU)

22108: Lincolnshire Poacher, CYP at 1321 in USB in progress //14487. (AB-NL)

22435: XSQ, Guangzhou Radio, Chn monitored at 0250 in SITOR-A 100/170 w/msgs to ships. (EW-AU)

22908.5: RAN Exmouth WA, Australia at 0405 w/VFT 16 Channel xmission. (IJ-NZ)

24210: Australian Defence Forces Radio (via VHC RAN Belconnen XMTers) at 0602 in USB w/relay commentary from 3JJJ 107.1 FM Melbourne, of the AFL grand final between the Carlton Blues and the North Melbourne Kangaroos. (IJ-NZ)

24644: Cherry Ripe No. Stn at 2210 in USB, YL w/numbers. //17499. (IJ-NZ)

27900: VMR264, Volunteer CG Swansea, NSW Australia at 2302 in AM w/the boat Striker logging on. VJ6LQ, Whitfords

Volunteer Sea Rescue Group INC, WA Australia at 0048 in AM w/the boat *Nadia253*, 4 POBs and 220 litres of fuel onboard heading to Rottneest Island. (IJ-NZ)

Contributors: (AB) Ary Boender, NL; (ALS) Allen Stern, Florida; (AWH) Albert W. Hussein; (BF) Bill Farley, New Mexico; (CS) Chris Steele, South Carolina; (EW) Eddy Waters, AU; (HOOD)

Robin Hood, UK; (IJ) Ian Julian, NZ; (JD) John Doe, UK; (JLM) Jack Metcalf, Kentucky; (JK) John Kasupski, New York; (MADX) MidAtlanticDXer, Maryland; (MR) Mike Rasmussen, Minnesota; (NJ) Noel Jones, NZ; (PP) Patrice Privat, FR; (RB) Your editor; (RP) Ron Perron, Maryland; (RP2) Ray Prestridge, Texas; (SD) Simon Denneen, AUS; and (SW) Sue Wilden, Indiana. ■

The book you've been waiting for...

CQ Amateur Radio Equipment Buyer's Guide

The CQ Amateur Radio Equipment Buyer's Guide lists practically every piece of Amateur Radio equipment currently offered for sale in the U.S., complete with specs and prices.

It's all here — from top-of-the-line HF transceivers to the smallest accessories.

The CQ Amateur Radio Equipment Buyer's Guide also includes the most comprehensive directory anywhere of Ham product manufacturers and dealers in the U.S., with phone numbers, FAX numbers, Web sites, and e-mail addresses.

ORDER YOURS TODAY!

For Fastest Service call 1-800-853-9797
 FAX 516-681-2926
 CQ Communications, Inc. 25 Newbridge Rd, Hicksville, NY 11801

Only **\$15.95**
 Plus \$4.00 Shipping & Handling



tuning in (from page 4)

"good news." Believe me, I've looked for it. You know — the silver lining in the cloud. If there is any "good news," it's for the Energizer Bunny folks and "Get Prepared For Y2K Now" video retailers I've seen on TV. These videos, our Red Cross, and Uncle Sam have correctly pointed out that beyond the very real possibility of major system failures, there's a potential disaster-in-the-waiting because of all the so-called embedded chips in everything from hair dryers (come 2000, I'm going for the Kojak look anyway) to security alarm systems.

Back to that Red Cross pamphlet for a moment. Right there on page one they say, "no one knows what problems may occur . . ." *No kidding?* Who do they work for, the Cartoon Network?

Call me crazy, but part of me is thinking it might be a good lesson if everyone loses power for an hour or so, 35 million car alarms in Manhattan ring in the New Year, and just as the ball in Times Square drops, Dick Clark loses his voice.

Something's going to happen if for no other reason than a special Senate Committee worked real hard to "define

the scope of the Y2K problem." (Too bad that meeting-of-the-elevator-doesn't-go-to-the-top-floor-minds wasn't convened at about 10 p.m. on December 31 as a real-world Y2K test). We can always count on our politicians to give it to us straight (well, no one can argue that fact that they *do* indeed give it to us, that's for sure). Don't look now, but here come the politicians waving their little penlight flashlights in the dark warning us about Y2K — and for Heaven's sake, don't ask Tausin or any of the others to put batteries in a *four-cell* flashlight. They'd likely need to form a committee and see a block diagram!

How prepared are you? It still isn't too late. You better run out and gas up the SUV, get some blankets, batteries, and bottled water — just in case. Prepare like the Red Cross says, "As you would . . . for a storm of any kind . . ." And please don't wait until the last weekend in 1999. And while you're at it, go ahead, get a generator — powerful enough to run the refrig, TV, and a few lights.

I wonder just how many of those portable generators will be returned to Sears the first weekend after January 1. Not mine. ■

New Midland Mobile CB With ESP™ 2 Noise Killer Circuit

Midland Consumer Radio just announced release of their model 77-120ESP Professional CB radio with their exclusive ESP™ 2 Noise Killer Circuit. It's no secret that excess noise interferes with CB communications and effectively shortens reception range. The new Midland patent-pending technology provides up to 95 percent noise reduction, even when communicating with other radios without ESP™ 2.



How does it work? ESP™ 2 senses the strength of the signal being processed and adjusts accordingly. If receiving a strong, clear signal, it allows it through with little or no noise reduction. As signals get weaker, or more noise is detected, the noise killer circuit adjusts automatically to boost the signal and filter more of the high and low frequencies, allowing middle frequency voices to come through loud and clear. The Midland news release said, "Other noise reduction schemes on the market only work when matched with another unit that has the same system, and often can make transmission worse when used with other models or brands."

The new 77-120ESP provides up-to-the-minute weather information with 10-channel weather/hazard broadcast reception. Its front-firing speaker provides maximum audio under high noise conditions. Notable performance features include microprocessor-controlled PLL tuning, a large backlit LCD display and selector buttons, and instant emergency Channel 9 access. Squelch, mic, and RF gain are all easily adjustable from the front panel.

The matte black case and modern styling give this CB a great look to match its performance. The retail price of the

new Midland CB is \$119.95. For more information, contact Midland Consumer Radio, Inc., 1670 N. Topping Avenue, Kansas City, MO 64120-3865 or phone 816-24-8500. You can also E-mail Midland at <midlndcb@tfs.net> or visit their Website at <<http://www.midlandradio.com>>. Don't forget to mention where you read about the new 77-120ESP CB!

Midland's SAME Weather/All Hazard Alert Monitor

No more false alarms waking you up in the middle of the night with weather or hazard alerts for areas three or four counties away. All too often, folks shut off the weather alert receiver, losing the benefit of early warning when emergencies strike their area.

The new Midland 74-200 SAME Weather/Hazard Radio receives regular NOAA broadcasts and features the new Specific Area Message Encoder (SAME) technology. It can be set to automatically switch to local NOAA broadcasts only when the alert tones are activated in the county or range of counties specified by the user (up to 15). Alerts for other areas are ignored. The 74-200 displays up to 56 messages on the front digital LCD panel, specifying the type of alert (tornado, flood, hurricane, etc.) and three-color LED indicators show at a glance if the alert is a statement, watch, or warning. The unit recognizes these also, so you can keep informed and move to safety. The telescoping fold-away antenna gives an approximate range of 50 miles from the transmitter, and with digital channel control, the tuning will never drift off frequency.

The 74-200 receiver features a built-in alarm clock. Optional accessories include an external antenna, strobe light, or pillow vibrator (all sold separately). A standard AC power adapter is included and 9-volt battery backup allows operation during a power outage (battery not included). It can also be powered from 12-volt vehicles or boats with Midland's Model 18-235 adapter (not included).

The radio measures (HWD) 2 1/8" x 7 7/8" x 5 1/4" and retails for \$79.95. For more information, contact Midland Consumer Radio, Inc., 1670 North



Topping Avenue, Kansas City, MO 64120 or phone 816-241-8500. You can also E-mail Midland at <midlndcb@tfs.net> or visit their Website at <www.midlandradio.com>.

Interested In Shortwave?

New from the Electronic DX Press is the *Australasian Shortwave Digest* by Bob Padula. With a minimum of eight pages guaranteed, this new publication comes in a professionally-printed and illustrated format. It includes news about international and domestic shortwave broadcasting, concentrating on, but not limited to, transmissions from or directed to Asia, the Far East, Siberia, the Western Pacific, Indian sub-continent, and Australia.

The Digest doesn't cover mediumwave, longwave, VHF-FM, TV, pirate, clandestine, harmonics, time signals, amateur, satellite, or utility transmissions. Frequency coverage is from 2300 to 26100 kHz and includes new schedules, stations, revised schedules, reception notes, spectrum studies, articles, frequency surveys, and much more.

We've seen Bob's *Australasian Shortwave Digest* and find it to be an excellent source of timely information, which can be a rarity, especially when it comes to shortwave! A subscription rate (six issues) is U.S. \$15 or 20 IRCs. Payment can be in cash, international money order, or bank draft. Traveller's checks are acceptable in any currency.

For more information, contact Bob Padula at Padula Books, 404 Mont Albert Road, Surrey Hills, Victoria 3127, Australia or phone +61-3-9898-2906 or E-mail Bob at <bpadula@compuserve.com>. Please don't confuse the "Digest" with their twice-yearly "Australasian Shortwave Guide." The next issue was planned December 1999.

advertisers index

AOR USA, Inc.	23
Alineo.....	33
Am-Com	27
Antenna Supermarket.....	37
Antique Radio Classified	32
Atomic Time, Inc.	31
Bill's CB & 2-Way Radio Ser	68
C. Crane Company	Cov III
C & S Sales, Inc.	47
CQ Amateur Radio Buyer's Guide..	77
CQ Amateur Radio Calendars.....	69
CQ Merchandise	29
CRB Research	28
Computer Aided Technologies	43
Cutting Edge Enterprises.....	25
DWM Communications	32
Durham Radio Sales & Ser., Inc.	32
Firestik Antenna Company.....	27
Flightline Engineering, Inc.	69
ICOM America, Inc.....	7
Jo Gunn Enterprises	69
Lee Electronics Company	68
Lentini Communications, Inc.....	1
MACO Mfg. /Majestic Comm.	67
MFJ Enterprises, Inc.	39
Monitoring Times.....	61
Optoelectronics, Inc.	5, Cov IV
PALSTAR, Inc.	31
Passport to World Band Radio	11
Phillips-Tech Electronics	69
REACT International, Inc.....	24
RadioWorld, Inc.	14
Scanning USA.....	32
Signal Engineering	68
SWAGUR Enterprises.....	19
TEN-TEC, Inc.	59
Universal Radio, Inc.	3
Viking Systems International	53
Wilson Antenna, Inc.....	45
World Radio Television Handbook 15	
WiNRADiO Communications	9
Yaesu U.S.A.	Cov. II

Reach this dynamic audience with your advertising message, contact Don Allen, W9CW at 217-344-8653, FAX 217-344-8656, or e-mail: PopComAds@aol.com

readers' market

Advertising Rates: Non-commercial ads are 30 cents per word, including abbreviations and addresses; minimum charge \$6.00 per issue. Ads from firms offering commercial products or services are \$1.00 per word; minimum charge \$20.00 per issue. Boldface words are \$1.20 each (specify which words). Leading key words set in all caps at no additional charge. All ads *must be prepaid in full* at time of insertion; a 5% discount is offered for prepaid 6 time insertions. All ads must be typewritten double spaced.

Approval: All ad copy is subject to Publisher's approval and may be modified to eliminate references to equipment and practices which are either illegal or otherwise not within the spirit or coverage scope of the magazine.

Closing Date: The 10th day in the third month preceding date of publication. Because the advertisers and equipment contained in Readers' Market have not been investigated, the Publisher of *Popular Communications* cannot vouch for the merchandise listed therein. Direct all correspondence and ad copy to: Attention: Alycia Nichol森, PC Readers' Market, 25 Newbridge Rd., Hicksville, NY 11801.

LEARN CODE BY HYPNOSIS — <http://www.qth.com/cweasy/>; or call 1(800) 425-2552.

RADIO STUFF SALE: Books, magazines, club bulletins, radio station items, old time radio & more. \$1 for list. G. Dexter, 213 Forest St., Lake Geneva, WI 53147.

GE SUPERADIO III with up to four SCS bands is the DX'ers choice. AM modification included. Low as \$85. 800-944-0630.

EXPERT RADIO REPAIR/ALIGNMENTS Military/Amateur/S.W.L. Fast, Economical R-388, R-390, R-390A, R-392, R-648/ARR-41, R-725, SP-600, T.M.C. CV-591A, CV-1758. Collins, Hammarlund, Hallicrafters. R-392 Power Supplies, R-390 Power cords. Rick Mish, MILTRONIX (419) 255-6220, 9-9 E.S.T. Fax 24 Hrs. **INTERNATIONAL WELCOMED.**

CB Tricks Books, Tricks I, II, or III. \$19.95 each. Repairs, tune-ups, amplifiers. Send Money Order to: Medicine Man, POB 37, Clarksville, AR 72830.

RadioShack SCANNERS LOWEST PRICES all catalog items. NEW-FRS 105 Family Radio Service 2-way HT reg. \$180 — **OUR PRICE \$150.** Join our buying club and save. No tax. Call 1-800-848-3004 (orders only). COTRONICS, Inc., 2250 S.E. Federal Hwy., Stuart, FL 34994.

Logging Software With QSL Imaging! — Designed for 21st-Century DXers, DXtreme SWRLgold™ lets you computerize your log and enjoy one-click access to your QSLs. Visit: www.dxtreme.com/dxtreme today!

GROUND IT Ham Station Grounding Accessories. J. Martin Systems 35 Hilltop Avenue, Stamford, CT 06907. Voicemail/ Fax 203-461-8768 <http://www.jmsystem.com>

CB MODIFICATIONS, REPAIRS, NEW PRODUCTS, SHOOTING STAR, GALAXY, SUPERSTAR, UNIDEN, COBRA, MIRAGE, RCI, PAOLMAR, RED DEVIL, MESSENGER, EXPORTS, POLICE/FIRE/MILITARY SCANNERS, MICROPHONES, POWER SUPPLYS, ANTENNAS, MORE!!! 15 yrs SAME LOCATION, 5 PAGE PICTURE PRICE SHEETS \$1.00 (REFUNDABLE) GALAXY, BOX-1202, AKRON, OH 44309.

CB MODIFICATION SECRETS, big new 200-page guide by Kevin Ross, author of "CB Radio Hacker's Guide." More great easy-to-do Am/SSB CB equipment upgrades and enhancements applicable to Cobra, Realistic, Uniden, President, etc. Freq. expansion, VFO, clarifier unlock, VOX, Roger Beep, anti-theft device, receive signal preamp, much more. Only \$21.95, plus \$5 s/h (\$6 to Canada) from CRB Research Books, P.O. Box 56, Commack, NY 11725. NY residents add \$2.22 tax. VISA/MC orders call: (516) 543-9169.

MILITARY RADIOS: Easily made battery adapters for military radios & other electronics. Get **POWER UP!** Big new 96-page manual of instructions, diagrams. Use readily available commercial batteries in PRC-6, -8, -9, -10, -25, -28, -47, -74, -77, TRC-77, AN/PRC-9, AN/PRT-4, RT-77, URC-68, more; also mine detectors, night scopes, radiacs, field telephones, etc. Only \$14.95, plus \$5 s/h (\$6 Canada). NYS residents add \$1.53 tax. CRB Research Books, Box 56-PC, Commack, NY 11725. VISA/MC accepted. Phone (516) 543-9169.

CB MODIFICATIONS! 10M, frequencies, sliders, amplifiers, FM, books, plans, kits, high-performance accessories, The best since 1976. Find out why! Catalog \$3. CBCI BOX 1898A, MONTEREY, CA 93942. <www.cbciintl.com>.

RF TRANSISTORS AND TUBES 2SC879, MRF454, MRF422, 2SC1969, MRF492, 2SB754, SD1446, MRF247, MRF317, 2SC2166, 3-500ZG, 2CX3000A7, 4CX250B, 7580W/ 4CX250R. WESTGATE 800-213-4563.

A.P COMMUNICATIONS MOBILE 10M RADIO. NEW DELT FORCE MAGNUM GALAXY, PRESIDENT 2510, RCI-2950, RCI-2970 BASE 10M RADIO. GALAXY-DX-2527, RCI-2980, RCI-2990. HF MOBILE AMP 10-80M, P-225W, P-250W, E-350W, E-400W, DX-600W, DX-1200W, DX-1600W, G-2.4K, G-3K, G-6K. CALL OR FAX (215)425-3073. SELL TO LICENSED, 20 PAGE PICTURE PRICE SHEETS \$2. 1421 E. HEWSON STREET, PHILADELPHIA, PA 19125.

WANTED: Pre-1990 issues of World Radio and TV Handbook (WRTH) and Passport to World Band Radio. Must be reasonable. If you have five different issues or more, call (630) 963-3658.

the loose connection

Radio Communications Humor

Y2K Predictions

By Bilious the Omniscient (the seer formerly known as N3AVY)

If you are reading this, the world did not end at the rollover of the Earth's odometer. (*Those of you who receive this issue before January 2000, disregard that — Ed*) And now, cast in stone (OK — ink) here are my predictions, just in time for you to see if I'm right.

I predict that your radio, television, cable, telephone, and utility service will be uninterrupted. Period.

I predict that there will be a genuine shortage of toilet paper, bread, milk, eggs, bottled water, and brie. This will not be due to real shortages, but to artificial shortages cause by large numbers of foolish people hoarding those items. The water and the paper will keep, but starting New Year's Day, a lot of stupid people will be eating a lot of French toast, egg sandwiches, and brie.

I further predict that several really mean-spirited people will quietly slip away from the festivities at about 11:55 p.m. December 31 and shut off the power mains to their house, apartment complex, or office precisely at midnight. Considering mankind's tendency to panic over darkness, and the unknown, and the intensification of this panic caused by alcohol, that prank will sometimes result in the perpetrator being crushed by a mob of drunks feeling their way to the breaker box. Few will look out the windows to notice that the rest of the neighborhood has power.

I predict we'll all pay for this. Irrational, worrisome hoarders will pay *before* the rollover by buying everything from whiskey and tobacco to donuts and Army surplus MREs (today's K-rations) at inflated prices. Rational, calm consumers will pay *after* New Year's Day by not having hoarded, and needing their normal supply of things, and finding shortages and inflated prices *after* Dick Clark's ball has dropped.

Ever alert to serve my readers, I attended the Federal Energy Regulatory Commission's Oil and Gas Industry Y2K Readiness Conference held Oct. 21, 1999. After the initial adrenaline rush, I learned that gasoline suppliers, gasoline retailers, convenience stores that sell

gasoline, and natural gas and propane distributors, will all have adequate supplies, have checked their systems, and are confident that everything will work properly come the Y2K rollover.

I have personally spoken with people in the electric power industry, who all assure me that:

A. Things have been tested and will work just fine, and

B. Even if they didn't, every system has a giant, manually-operated switch — and a person whose only job it is to throw that switch if the automatic system fails — standing by at great expense to utilities which are paying double-time to enormous workforces who are standing-by over the holiday weekend, and

C. Someone's gonna pay for all this.

It was interesting to hear a comment by the representative of a major oil company say something to the effect of, "Even if commercial communications systems would all fail, we have plans to shift to cell phones, and if they fail, we'll switch to trunked 800 MHz radio systems, and if they fail, we'll go to satellite-telephones. If all of those systems fail, we can still go back to the old two-way VHF radios." Imagine that. Back to the Stone Age.

For those of you who read and heeded Harold ("*Hey — free electricity*") Ort's treatise on solar power for backup battery-charging and emergency use in September's *Pop'Comm*, life will be good. For those of you who threw money at Y2K by buying a big generator at an inflated price ("*Hey — ya' want one or not? There's a six-month waiting list . . .*") some of us will be around to buy them at about half-price in January. And much less in February.

I predict that the following people will work over the entire holiday weekend:

- The U.S. Coast Guard
- Those other four branches of the U.S. military
- Everyone who's ever been certified as a police officer
- Everyone in the banking business below the rank of "vice-president in charge of chained-ballpoint-pens"

• Everyone who even *knows someone* in the news business

• Every "industry spokesperson," living or dead

I predict that all 276 major networks will cover the "Y2K Crisis" beginning at midnight, December 30 and continue tirelessly for 48 solid hours, reporting and analyzing every real event, every possible consequence of anything that could even remotely go wrong, and every non-event which occurs (or does not occur, depending on your point of view). Network "Y2K experts" will talk to one another, using such astute phrases as, "That's right, John," and "Yes, that certainly is a possibility." They'll interview each other until callers tell them how ridiculous they sound, at which time some of them will have the good sense to go home and have the station run a movie or play music.

I predict that even as I write, the major battery manufacturers — the folks who bring us AAA, AA, C, D, and 9V batteries — are cranking out all they can, and selling them to stores who'll take all they can get, knowing that every last one will be sold by December 31, regardless of price. Alert readers will want to offer to buy some of those batteries from their neighbors — the ones with bomb-shelters — come January. About 25 cents per battery should do it.

Finally, I predict a happy new year, decade, century, and millennium for *Pop'Comm* readers everywhere. In anticipation of the Y2K problem, the only change in my lifestyle was to forsake my electric guitar in favor of some really fine, (manually-operated) chromatic harmonicas — *Hering* harmonicas, from Brazil, which I now play wherever it's not forbidden by law or big mean people. I can sometimes be seen apprenticing at my "Y2K contingency job," playing jazz harmonica next to an upturned hat by the fountain near Washington DC's Union Station.

P.S. — This year, if you're not happy enough, just do something really nice for someone else. Money back if you're not satisfied. Void where prohibited. Residents of Washington and Vermont need not enclose return postage. So there. ■

BY BILL PRICE, N3AVY

25th
Anniversary

SANGEAN

*Celebrating
25 Years of
Excellence in Radio*



Sangean ATS909

***The Last Shortwave Receiver
You'll Ever Need to Buy!***

- 306 Memory Presets, 29 Separate Pages
- True Upper and Lower SSB
- 5 Tuning Methods
- 42 World City Times
- RDS Reception
- AM/FM Stereo thru Headphones
- Built-in SW Antenna Jack
- Dual Time Clock with Alarm
- Lighted LCD Display
- Incl. Carrying Case, SW Antenna, Earbuds

\$259⁹⁵ Includes U.S. Shipping

CIRCLE 162 ON READER SERVICE CARD

SANGEAN
AMERICA, INC.

www.sangean.com



CCRadio "Platinum Edition"

***The Best AM Radio Made Today
And Now A Perpetual Radio!****

- AM, FM, TV Audio, Weather Band + Alert
- **NEW!** Built-in 6V DC Input Jack & Charging Circuit
- Built-in LED Light Jack
- Audio Tuned for Human Voice
- 5 Memory Buttons Per Band
- Rotary Tuning Knob with 1KHz Fine Tuning
- Lighted Digital Display

\$164⁹⁵ Includes U.S. Shipping

*Optional Solar Kit Includes: Solar Panel, LED Light,
4 (4,000 mAh) Nicad Batteries and AC Charging Adapter
\$129.95 with purchase

Available Exclusively From C. Crane Company



**800-522-8863 or ccrane.com
Call for FREE CATALOG**

THE ALL NEW MULTICOUNTER

\$399



TA100S Antenna Included
U.S. Pat. No. 5,471,402

Optoelectronics presents the **NEW Multicounter** CD100 Counter / Decoder. The **Multicounter** combines a frequency counter and tone decoder in one handheld package. As the **Multicounter** locks onto a nearby RF signal, the frequency along with either **CTCSS**, **DCS**, **LTR**, or **DTMF** is instantly shown on the two-line LCD display. Like the popular Optoelectronics Scout, the **Multicounter** also **Reaction Tunes** many radios for instant monitoring of the frequency captured.

ORDER NOW

The **Multicounter** is so easy to operate that it is ideal for quick radio checks by a two-way radio technician or the hobbyist looking for unknown frequencies and tones.

FEATURES

- 10MHz - 1GHz Frequency Range
- Measures frequency and tone in < 1 second
- Decodes CTCSS, DCS, LTR, and DTMF
- LTR displays Area code, Go to Repeater, Home Repeater, ID, and Free repeater
- Built-in .5ppm TCXO for accurate frequency measurement
- Reaction Tune the ICOM R10, R7000, R7100, R8500, R9000, AOR AR8000, AR8200, OS456/Lite, OS535, Optoelectronics R11, and Optocom.
- Two Line LCD Display with EL backlight
- Internal memory for frequency / tone measurement
- Download memory to PC with optional Optolinx PC interface
- Patented Digital Auto Filter



Reaction Tune Scanner Not Included

CIRCLE 158 ON READER SERVICE CARD

OPTODIRECT 800-327-5912
OPTOELECTRONICS

5821 NE 14th Avenue • Ft. Lauderdale, FL 33334 • Visa • MasterCard • C.O.D. •
Prices and Specifications are subject to change without notice or obligation
Tel: 954-771-2050 Fax: 954-771-2052 Email: sales@optoelectronics.com Internet: www.optoelectronics.com